

0199

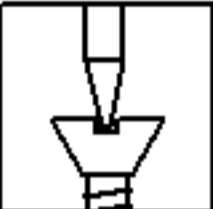

0197

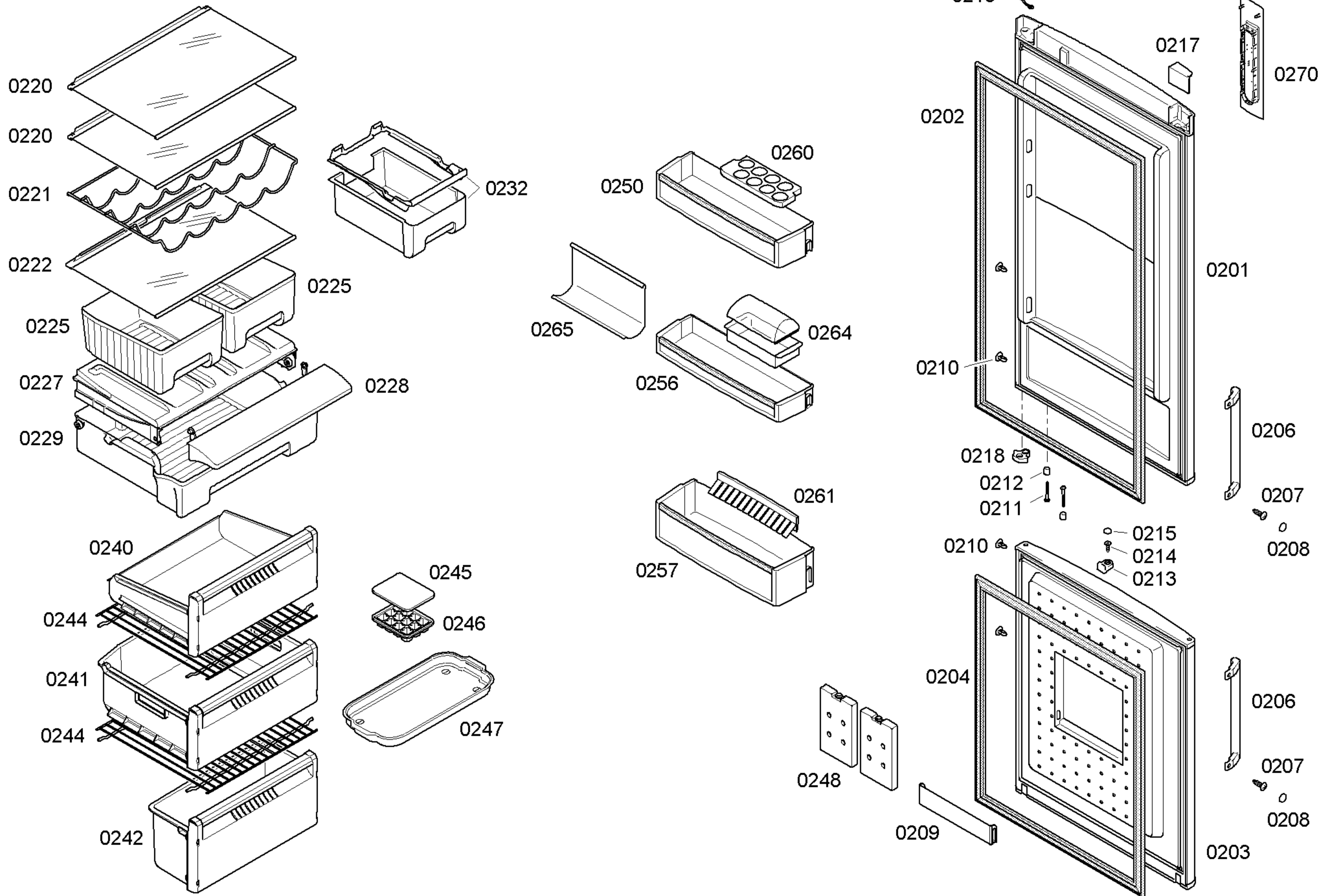

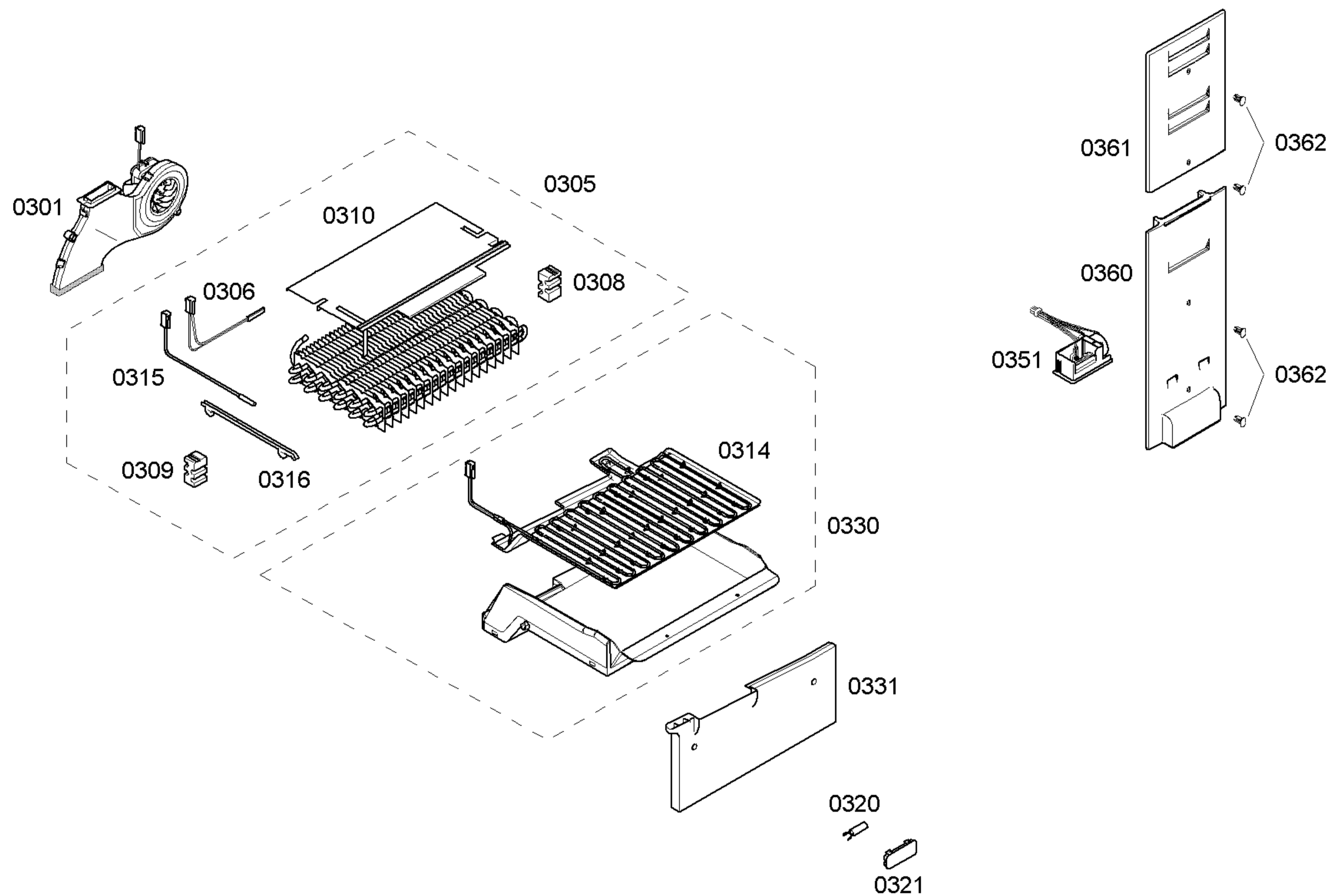

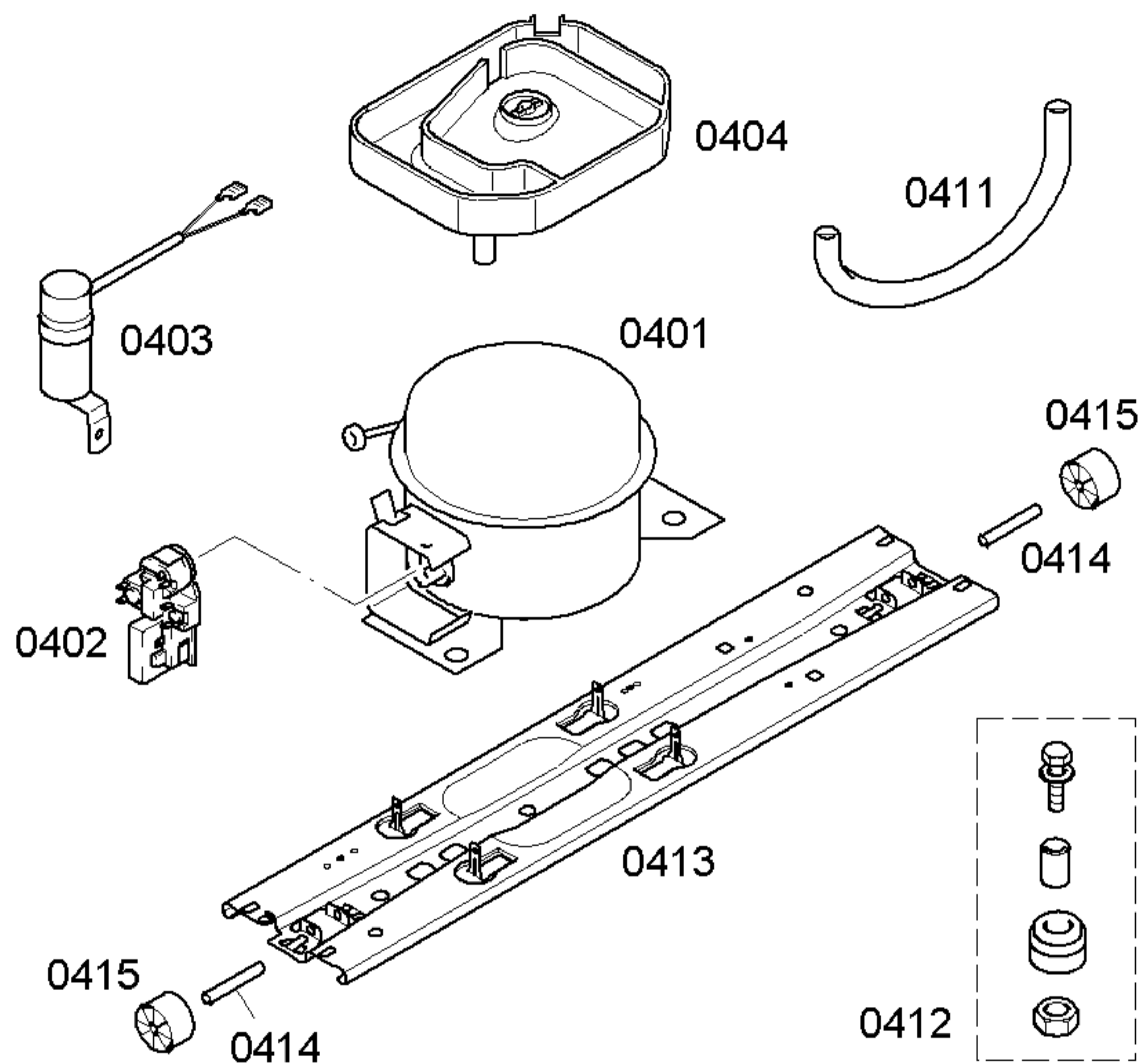

TECHNISCHE DATEN / TECHNICAL DATA / DONNEES TECHNICUES / DATOS TECNICOS						
Test conditions: CECOMAF (evap. temp. -25°C)						
Verdichter/Compressor/Compresor		Matsushita	Danfoss	Matsushita	Danfoss	Danfoss
Typ/Type/Tipo		DG91E	NLX8.8KK.2	DG100E	NLX10KK.2	NLE11KTK
Anlaufkondensator/Runing capacitor/Condensador de marcha		NO	YES	NO	YES	NO
Stromverbraucht/Current consumption/Int. consumo	A	0,64	0,37	0,70	0,44	0,95
Leistungverbraucht/Power consumption/Potencia cons.	W	95,00	76,00	109,00	89,50	123,00
C.O.P.	WW	1,20	1,49	1,20	1,49	1,03
Kühlleistung/Cooling capacity/Potencia frigorífica	W	114	113	131	133	127
Füllmenge/Fill. quantily/Charge/Carga	R600a. g	*	*	*	*	*

* Siehe Typenschild /See identification plate /Voir plaquette de caractéristiques /Ver plaqueta de características