

S/M No: RNRSU20001

Service Manual

Refrigerator

*FRN-U20IE**
*FRS-U20IE**

*FRN-U20BE**
*FRS-U20BE**

*FRN-U20DE**
*FRN-U20EE**
*FRS-U20DE**
*FRS-U20EE**

*FRN-U20FE**
*FRN-U20GE**
*FRS-U20FE**
*FRS-U20GE**

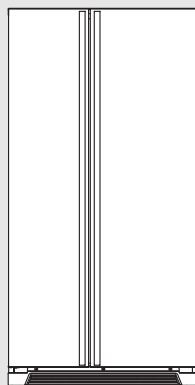

FRU-57BI~

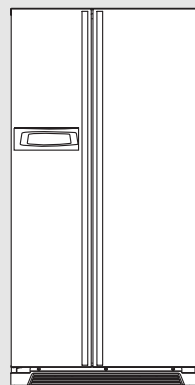

FRU-57BB~

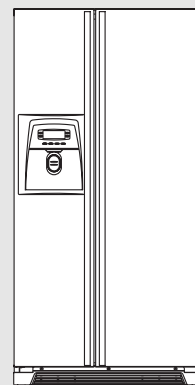

FRU-54BD~
FRU-54BE~

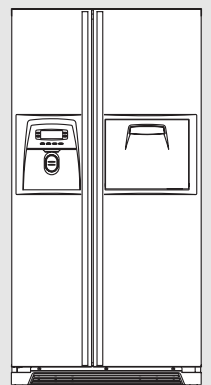

FRU-54BF~
FRU-54BG~

✓ Caution

: In this Manual, some parts can be changed for improving, their performance without notice in the parts list. So, if you need the latest parts information, please refer to PPL(Parts Price List) in Service Information Center

DAEWOO
ELECTRONICS



- Jan, 2007

DAEWOO

CONTENTS

| | |
|--|----------|
| 1. WARNINGS AND PRECAUTIONS FOR SAFETY | -----2 |
| 2. EXTERNAL VIEW | |
| 2-1. External Size | -----3 |
| 2-2. Name of Each Parts | -----6 |
| 2-3. Cold Air Circulation | -----8 |
| 3. SPECIFICATION | -----9 |
| 4. OPERATION AND FUNCTIONS | -----11 |
| 5. WIRING DIAGRAM | -----35 |
| 6. COMPONENT LOCATE VIEW | -----40 |
| 7. HOW TO CHECK EACH PARTS | |
| 7-1. Hose Ice Maker Tube | -----42 |
| 7-2. Bracket Geared Motor | -----43 |
| 7-3. Dispenser Micro Switch | -----44 |
| 7-4. Dispenser Solenoid Valve | -----45 |
| 7-5. Main PCB | -----46 |
| 7-6. Ice Maker | -----48 |
| 8. TROUBLE DIAGNOSIS | |
| 8-1. Power Failure | -----50 |
| 8-2. Freezer Compartment | -----51 |
| 8-3. Refrigerator Compartment | -----57 |
| 8-4. Operation Noise of Refrigerator | -----62 |
| 8-5. Door | -----68 |
| 9. COOLING CYCLE HEAVY REPAIR | |
| 9-1. Summary of Heavy Repair | -----69 |
| 9-2. Precaution during Heavy Repair | -----70 |
| 9-3. Practical Work for Heavy Repair | -----71 |
| 9-4. Standard Regulations for Heavy Repair | -----73 |
| 9-5. Brazing Reference Drawing | -----74 |
| 10. INSTALLATION GUIDE | |
| 10-1. Installation Preparation | ----- 75 |
| 10-2. If the Refrigerator can not enter the Door | ----- 76 |
| 10-3. Refrigerator Leveling & Door Adjustment | -----77 |
| 10-4. Water Line Installation | ----- 79 |
| 10-5. Dispenser Water Flow | ----- 81 |
| 11. EXPLODED VIEW & PARTS LIST | -----82 |

1. WARNINGS AND PRECAUTIONS FOR SAFETY

Please observe the following safety precautions in order to use safely and correctly the refrigerator and to prevent accident and danger during repair.

1. Be care of an electric shock. Disconnect power cord from wall outlet and wait for more than three minutes before replacing PCB parts.
Shut off the power whenever replacing and repairing electric components.
2. When connecting power cord, please wait for more than five minutes after power cord was disconnected from the wall outlet.
3. Please check if the power plug is pressed down by the refrigerator against the wall.
If the power plug was damaged, it may cause fire or electric shock.
4. If the wall outlet is over loaded, it may cause fire.
Please use its own individual electrical outlet for the refrigerator.
5. Please make sure the outlet is properly earthed, particularly in wet or damp area.
6. Use standard electrical components when replacing them.
7. Make sure the hook is correctly engaged.
Remove dust and foreign materials from the housing and connecting parts.
8. Do not fray, damage, machine, heavily bend, pull out or twist the power cord.
9. Please check the evidence of moisture intrusion in the electrical components.
Replace the parts or mask it with insulation tapes if moisture intrusion was confirmed.
10. Do not touch the icemaker with hands or tools to confirm the operation of geared motor.
11. Do not let the customers repair, disassemble and reconstruct the refrigerator for themselves.
It may cause accident, electric shock, or fire.
12. Do not store flammable materials such as ether, benzene, alcohol, chemicals, gas, or medicine in the refrigerator.
13. Do not put flower vase, cup, cosmetics, chemicals, etc., or container with full of water on the top of the refrigerator.
14. Do not put glass bottles with full of water into the freezer.
The contents shall freeze and break the glass bottles.
15. When you scrap the refrigerator, please disconnect the door gasket first and scrap it where children are not accessible.

2. EXTERNAL VIEWS

2-1. External Size

- FRS(N)-U20IE*

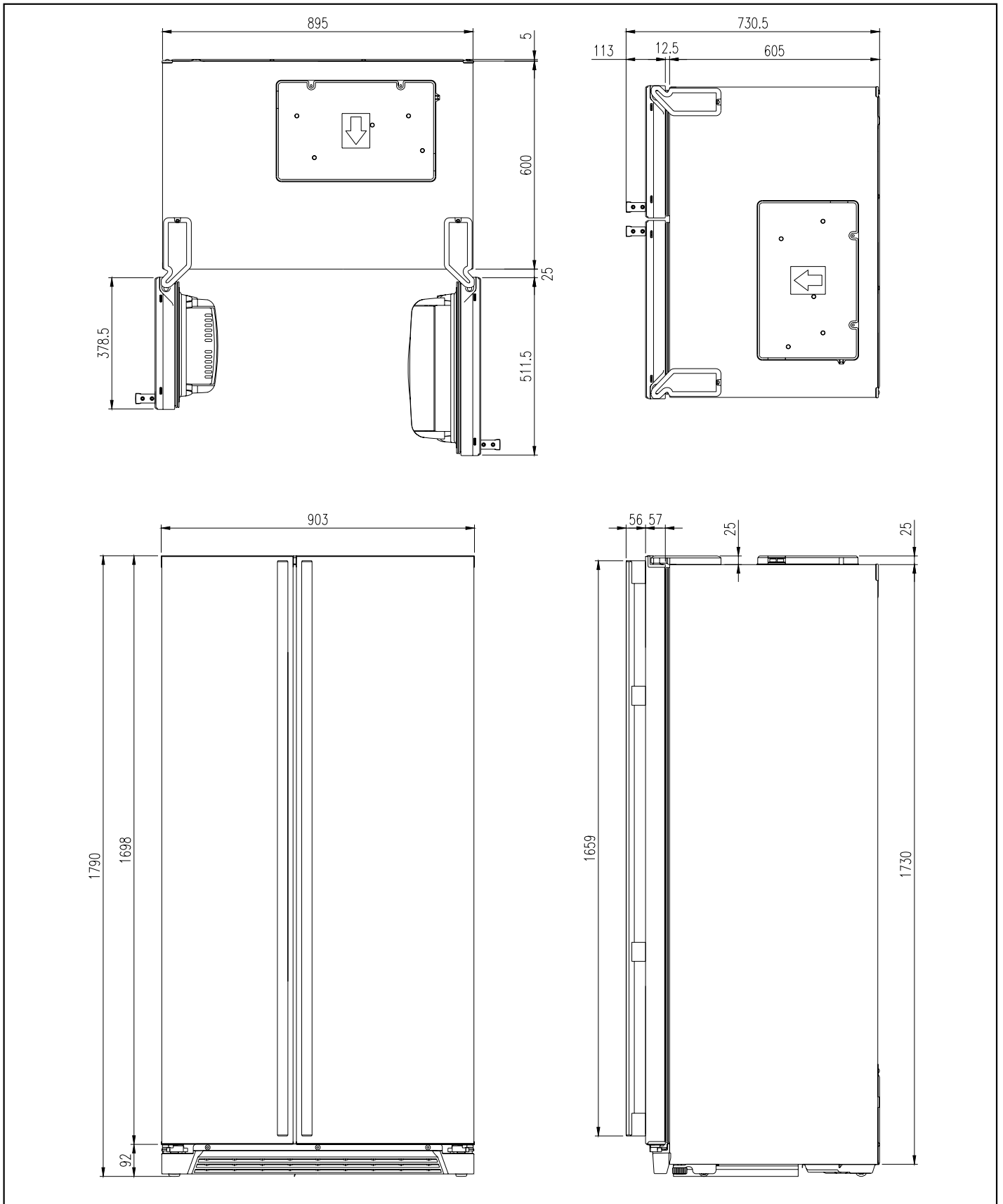

- FRS(N)-U20DE* / EE*

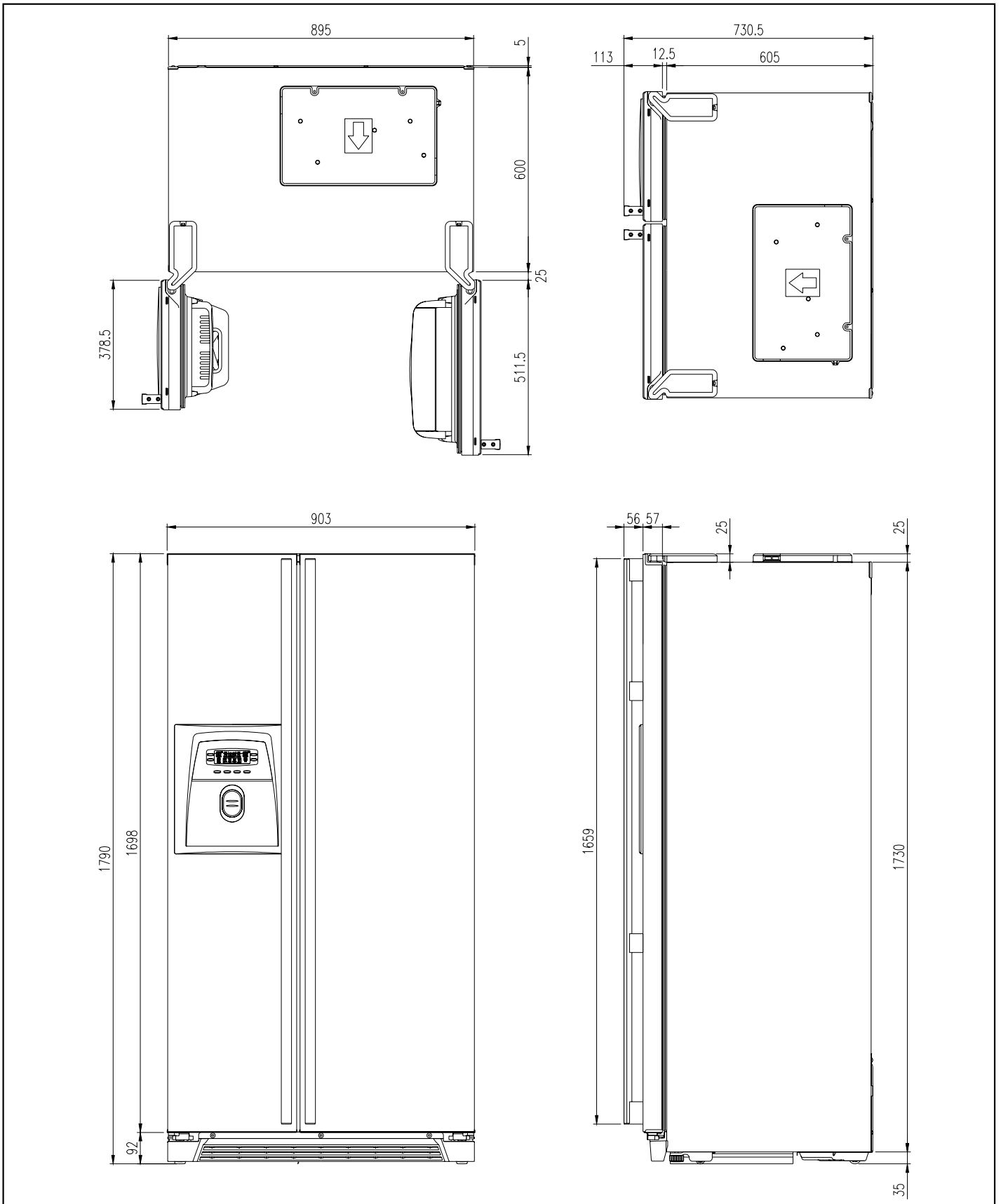

- FRS(N)-U20FE* / GE*

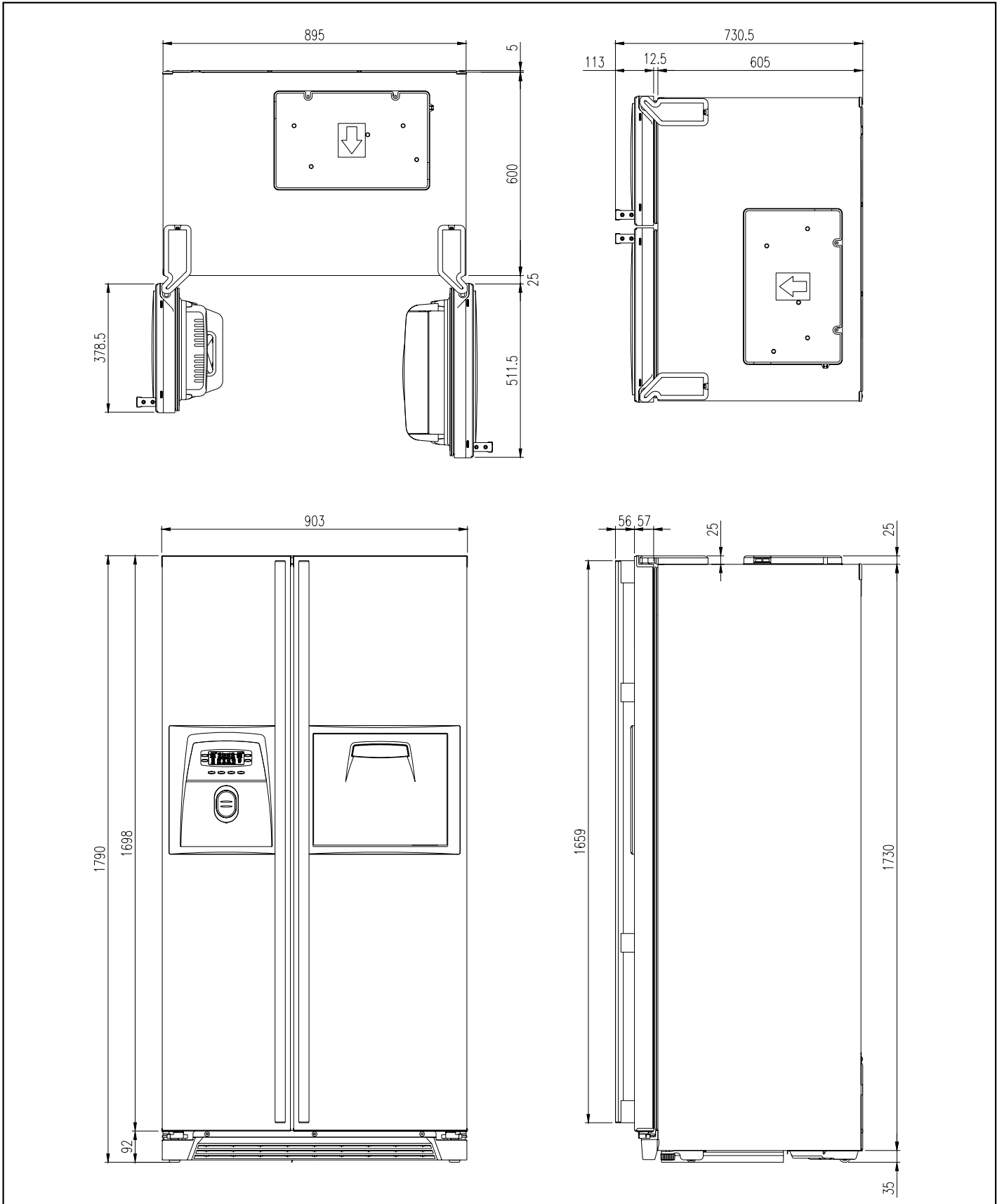

2-2. Name of Each Parts

- Basic Model

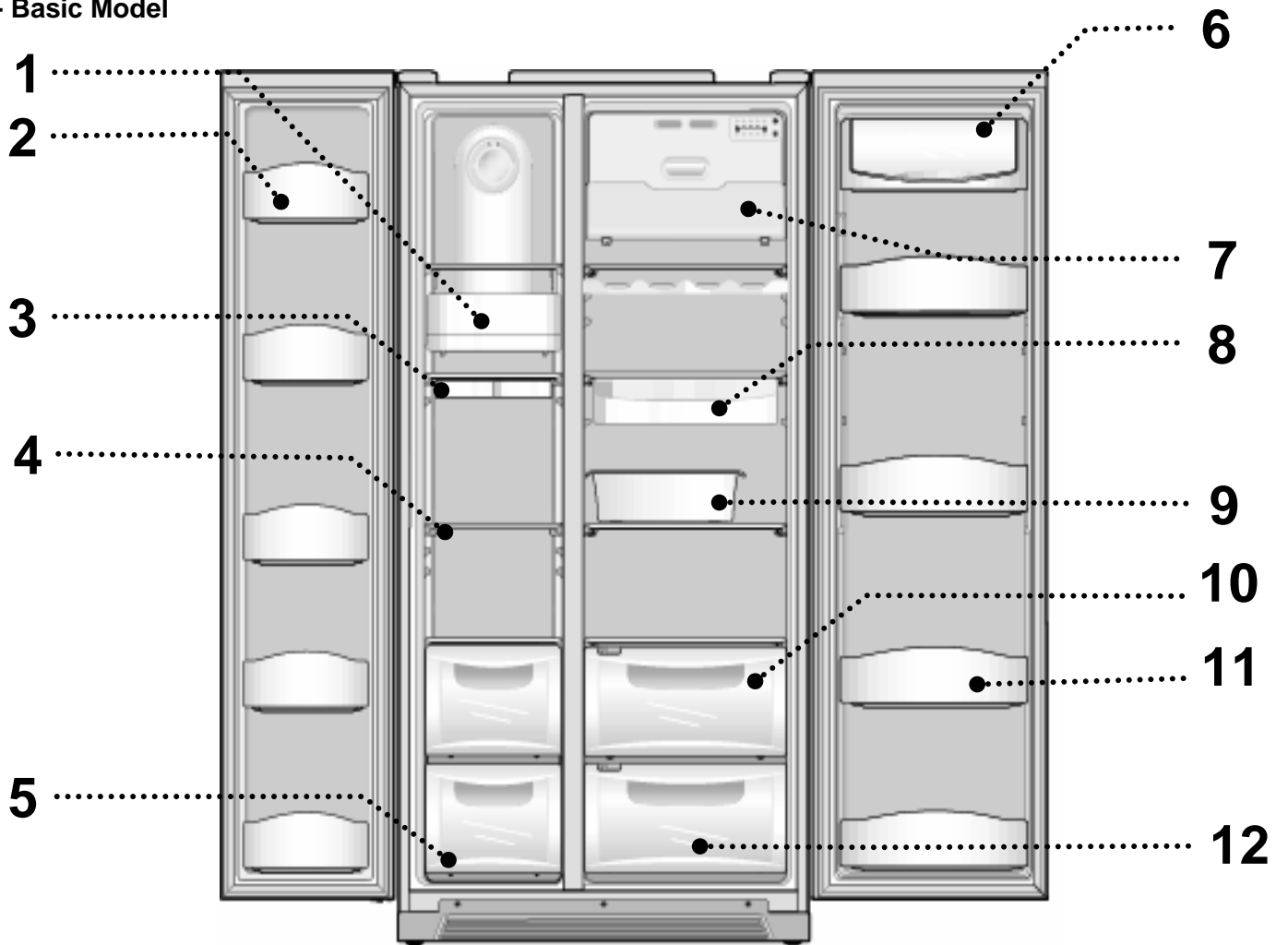

- Wine Rack is option

| Freezer Compartment | Refrigerator Compartment |
|---------------------|--------------------------|
| 1. Freezer light | 6. Dairy pocket |
| 2. Freezer pocket | 7. Refrigerator light |
| 3. Ice tray | 8. Chilled case |
| 4. Freezer shelf | 9. Movable Egg case |
| 5. Freezer case | 10. Refrigerator shelf |
| | 11. Refrigerator pocket |
| | 12. Refrigerator case |

- Full option Model

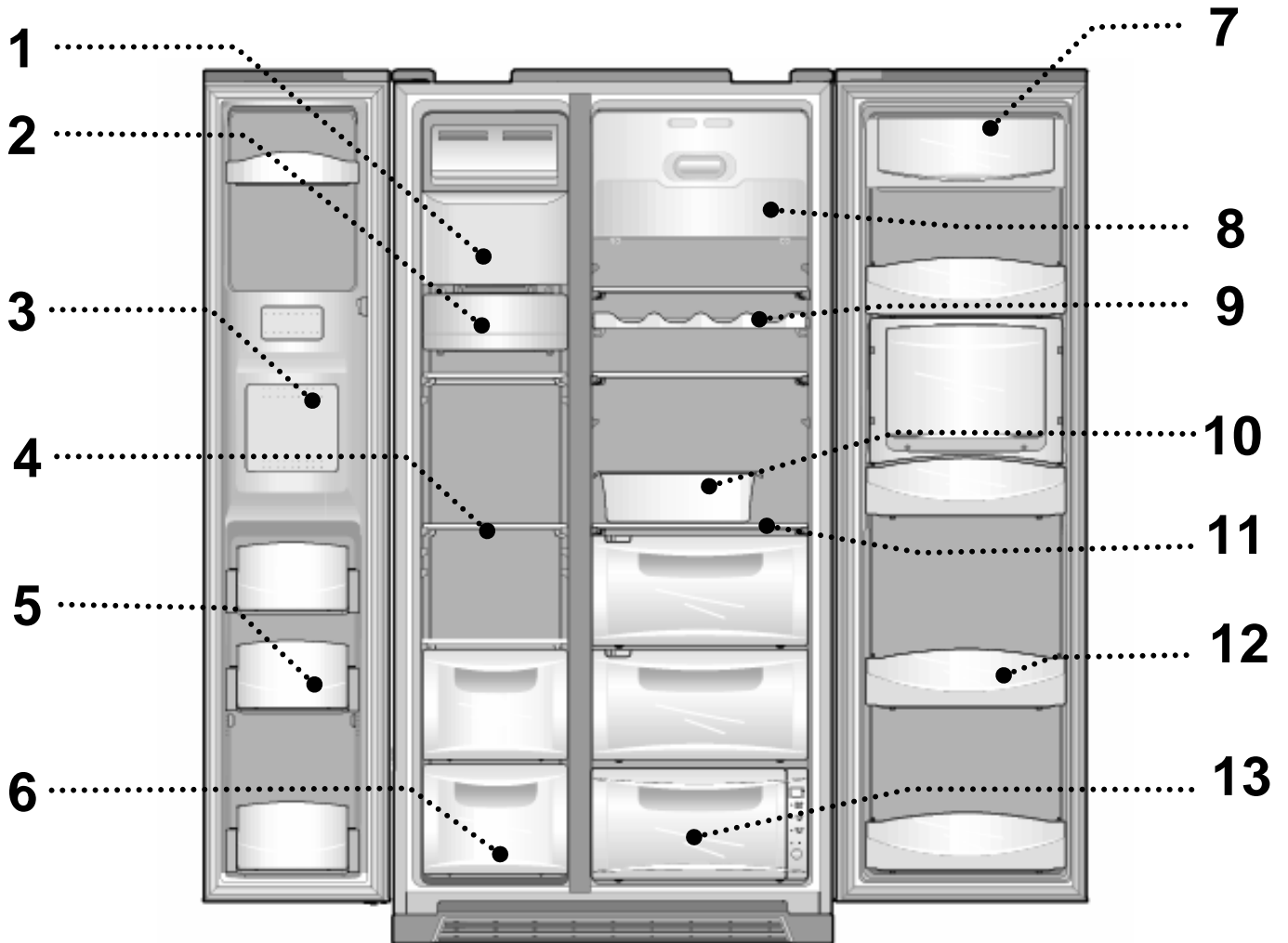

-Full option Model illustrated.
 -Features are model dependent.

| Freezer Compartment | Refrigerator Compartment |
|---------------------------|--------------------------|
| 1. Ice cubes storage case | 7. Dairy pocket |
| 2. Freezer light | 8. Refrigerator light |
| 3. Water/Ice Dispenser | 9. Wine Rack |
| 4. Freezer shelf | 10. Movable Egg case |
| 5. Freezer pocket | 11. Refrigerator shelf |
| 6. Freezer case | 12. Refrigerator pocket |
| | 13. Magic room (option) |

2-3. Cold Air Circulation

Freezer
Compartment

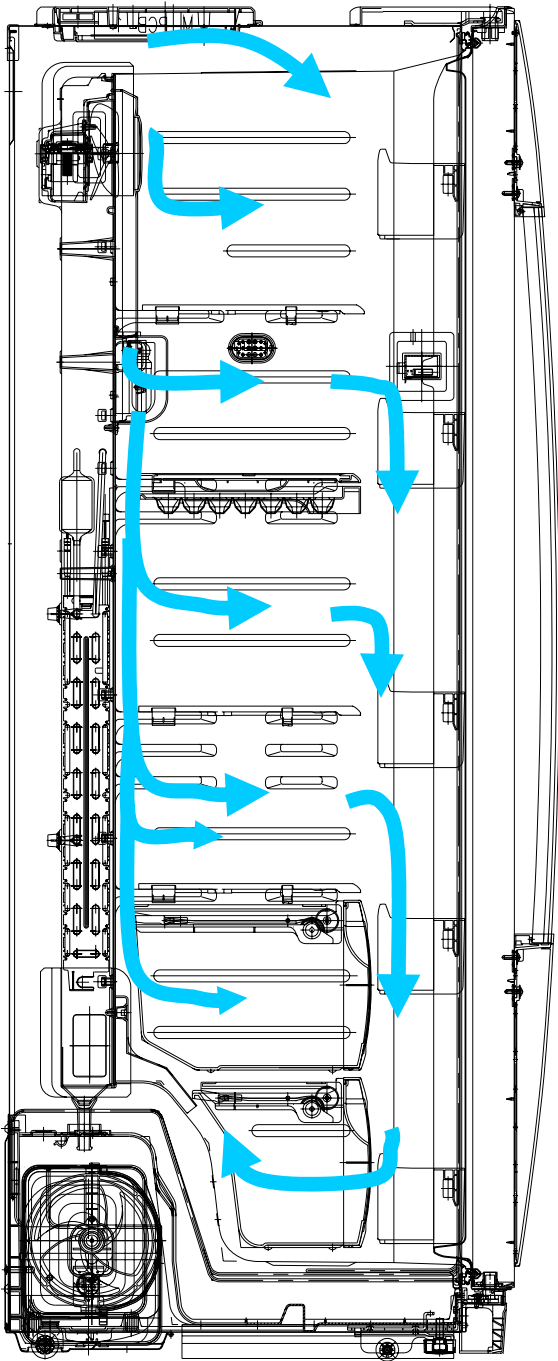

Refrigerator
Compartment

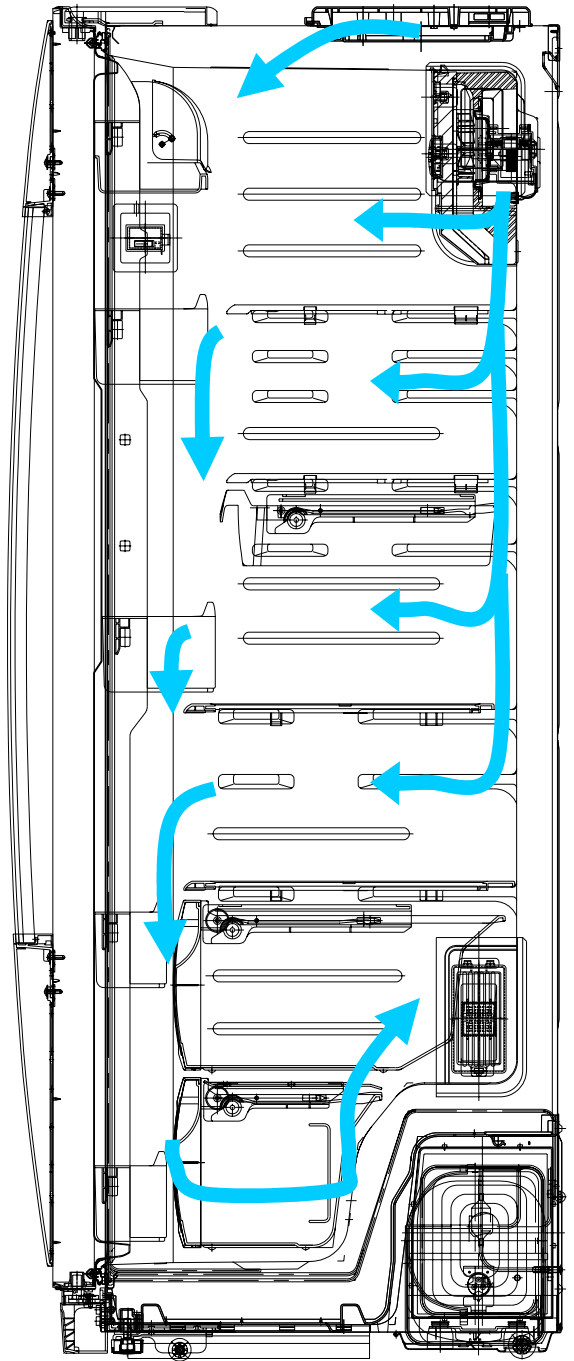

3. SPECIFICATION

3-1. Specification

| Item | | Specification | | | | | |
|---|----------------|-------------------------------|--------|--------|--------|--------|--------|
| Model Name | | U20IE* | U20BE* | U20DE* | U20EE* | U20FE* | U20GE* |
| ISO Gross Volume (Li) | Total | 570 Li | 570 Li | 541 Li | 525 Li | 541Li | 536 Li |
| | Freezer | 209 Li | 209 Li | 184 Li | 178 Li | 184 Li | 184 Li |
| | Refrigerator | 361 Li | 361 Li | 357 Li | 337 Li | 357 Li | 352 Li |
| ISO Storage Volume (Li) | Total | 537 Li | 537 Li | 504 Li | 504 Li | 504 Li | 500 Li |
| | Freezer | 198 Li | 198 Li | 170 Li | 170 Li | 170 Li | 170 Li |
| | Refrigerator | 339 Li | 339 Li | 334 Li | 334 Li | 334 Li | 330 Li |
| Weight | | 104kg | 104kg | 113kg | 115kg | 115kg | 117kg |
| External Dimension (Width x Depth x Height) | | 903 mm x 734.5mm x 1790 mm | | | | | |
| C Y C L E | Evaporator | Fin Type | | | | | |
| | Condenser | Fan Cooling System | | | | | |
| | Dryer | Molecular Sieve XH-9 | | | | | |
| | Capillary Tube | ID Φ 0.7 × T0.55 × L2200 | | | | | |

| Item | | Specification (220~240V Models only) | |
|---|------------------------|--|-----------------|
| Model Name | | Basic Model | Dispenser Model |
| D E F O R E S T | D-Sensor | PBN-43 | |
| | F-Sensor | PBN-38 | |
| | R-Sensor | PBN-43 | |
| H E A T E R | Defrost Heater | AC220V / 192W | |
| | Main Duct Heater | AC220V / 7W | |
| | Louver Heater | AC220V / 8W | |
| | Dispenser Heater | - | AC220V / 5W |
| | Water Pipe Heater | - | AC220V / 5W |
| E L E C T R I C A L P A R T S | Main Fuse (Power cord) | AC250V 15A | |
| | Fuse Temp (Defrost) | AC250V , 10A , 77℃ | |
| | F-Fan Motor | DC13V / 2050±100 rpm | |
| | R-Fan Motor | DC13V / 1950±100 rpm | |
| | Condenser Fan Motor | DC13V / 1100±100 rpm | |
| | F-Lamp | AC230~240V / 25W (2EA) | |
| | R-Lamp | AC230~240V / 25W (2EA) | |
| | Door Switch , F / R | SP201R-7DL / SP201R-7DR (SPF101B-2D / SPF101B-1D) | |

※ () is the specification for the model which use R-600a(refrigerant)

4. OPERATION AND FUNCTIONS

4-1. Display

4-1-1. FRS(N)-U20IE* Type

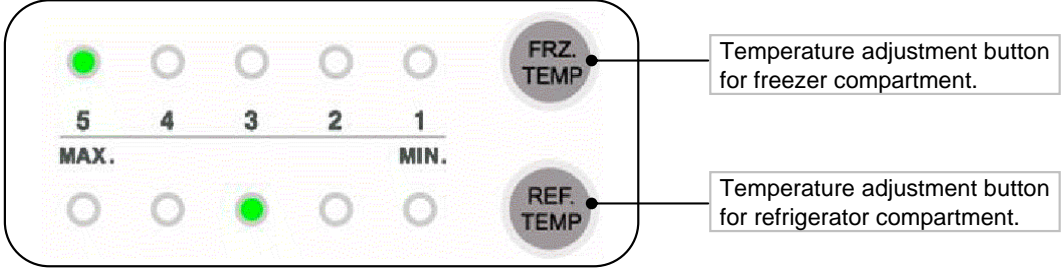
| INPUT | CONTROL OBJECT | | | | | | | | | | | | | | | | | | | | | | | | |
|---|--------------------------|-------------------|-----|------------|-----|------------|-----|-----------------|---|---|---|---|---|--------------------|-----|------------|-----|------------|-----|-----------------|---|---|---|---|---|
| FRZ.TEMP, REF.TEMP | Inner Control (Lamp-LED) | | | | | | | | | | | | | | | | | | | | | | | | |
| CONTENTS | | | | | | | | | | | | | | | | | | | | | | | | | |
|  | | | | | | | | | | | | | | | | | | | | | | | | | |
| REMARKS | | | | | | | | | | | | | | | | | | | | | | | | | |
| <p>1. "FRZ.TEMP" Button</p> <ol style="list-style-type: none"> 1) Temperature control of Freezer compartment 2) 5 step mode of successive temperature mode. 3) Initial mode by power input : "3" <p>※Whenever pressing button, setting is repeated in the order of Medium(3) → Medium Max(4) → Max(5) → Min(1) → Medium Min(2).</p> <table border="1" data-bbox="153 1200 1166 1319"> <thead> <tr> <th>Temperature Chang</th> <th>Min</th> <th>Medium Min</th> <th>Mid</th> <th>Medium Max</th> <th>Max</th> </tr> </thead> <tbody> <tr> <td>Temp indication</td> <td>1</td> <td>2</td> <td>3</td> <td>4</td> <td>5</td> </tr> </tbody> </table> <p>2. "REF.TEMP" button.</p> <ol style="list-style-type: none"> 1) Temperature control of Refrigerator compartment 2) 5 step mode of successive temperature mode. 3) Initial mode by power input : "3" <p>※Whenever pressing button, setting is repeated in the order of Medium(3) → Medium Max(4) → Max(5) → Min(1) → Medium Min(2).</p> <table border="1" data-bbox="153 1617 1166 1736"> <thead> <tr> <th>Temperature Change</th> <th>Min</th> <th>Medium Min</th> <th>Mid</th> <th>Medium Max</th> <th>Max</th> </tr> </thead> <tbody> <tr> <td>Temp indication</td> <td>1</td> <td>2</td> <td>3</td> <td>4</td> <td>5</td> </tr> </tbody> </table> <p>※ The actual inner temperature varies depending on the food status, as the indicated setting temperature is a target temperature, not actual temperature within refrigerator.</p> <p>※ Refrigeration function is weak in the initial time. Please adjust temperature as above after using refrigerator for minimum2~3 days.</p> | | Temperature Chang | Min | Medium Min | Mid | Medium Max | Max | Temp indication | 1 | 2 | 3 | 4 | 5 | Temperature Change | Min | Medium Min | Mid | Medium Max | Max | Temp indication | 1 | 2 | 3 | 4 | 5 |
| Temperature Chang | Min | Medium Min | Mid | Medium Max | Max | | | | | | | | | | | | | | | | | | | | |
| Temp indication | 1 | 2 | 3 | 4 | 5 | | | | | | | | | | | | | | | | | | | | |
| Temperature Change | Min | Medium Min | Mid | Medium Max | Max | | | | | | | | | | | | | | | | | | | | |
| Temp indication | 1 | 2 | 3 | 4 | 5 | | | | | | | | | | | | | | | | | | | | |

4-1-2. FRS(N)-U20BE* Type

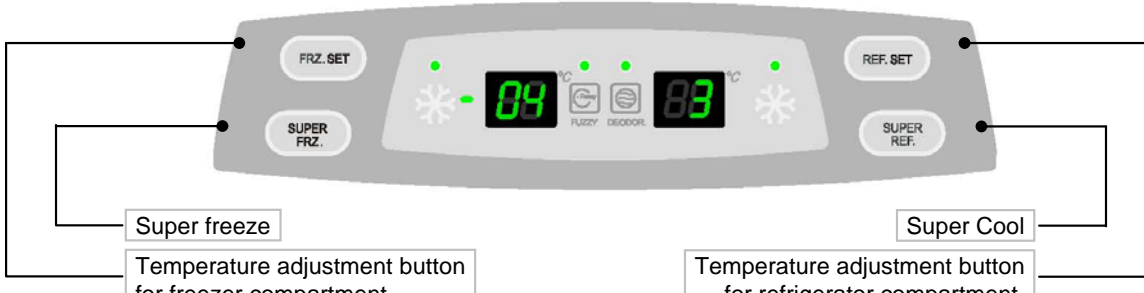
| INPUT | CONTROL OBJECT | | | | | | | | | | | | | | | | | | | | | | | | | | | | | | | | | | | | | | | | |
|---|---|-----------|-----------|------------------------|---|--------------------------------|-----------|------------------|----|--------------------|--------------|-----------|-----------|-----------|-----------|-----------|-----------|-----------------|---------------|------|------|------------|------------|------|------|--------------------|--------------|-----------|-----------|-----------|-----------|-----------|-----------|-----------------|-------------|----|----------|----------|----|----|----|
| Front PCB button Freezer Set , Refrigerator Set Super Freeze , Super Cool | FCP LED | | | | | | | | | | | | | | | | | | | | | | | | | | | | | | | | | | | | | | | | |
| CONTENTS | REMARKS | | | | | | | | | | | | | | | | | | | | | | | | | | | | | | | | | | | | | | | | |
|  <p style="text-align: center;"> Super freeze Super Cool Temperature adjustment button for freezer compartment. Temperature adjustment button for refrigerator compartment. </p> | | | | | | | | | | | | | | | | | | | | | | | | | | | | | | | | | | | | | | | | | |
| <p>1. Display control</p> <table border="1" style="width: 100%; border-collapse: collapse;"> <thead> <tr> <th style="width: 50%;">FCP-LED</th> <th style="width: 50%;">Control</th> </tr> </thead> <tbody> <tr> <td>88 Display (Set Temp.)</td> <td>Initial mode : Freezer & Refrigerator set → Normal (-19℃/4℃)</td> </tr> <tr> <td>Super Freeze , Super Cool Icon</td> <td>Dial</td> </tr> <tr> <td>FUZZY,DEODOR LED</td> <td>ON</td> </tr> </tbody> </table> <p>2. "Freezer Set" Button</p> <ol style="list-style-type: none"> 1) Temperature control of freezer compartment 2) 7 step mode of successive temperature mode. 3) Initial mode by power input : "-19℃" <p>※ Whenever pressing button, setting is repeated in the order of (-19℃) → (-20℃) → (-21℃) → (-22℃) → (-16℃) → (-17℃) → (-18℃).</p> <p>Letters are indicated on 88 Display LED</p> <table border="1" style="width: 100%; border-collapse: collapse; text-align: center;"> <thead> <tr> <th style="width: 12.5%;">Temperature Change</th> <th style="width: 12.5%;">Initially On</th> <th style="width: 12.5%;">1st Press</th> <th style="width: 12.5%;">2nd Press</th> <th style="width: 12.5%;">3th Press</th> <th style="width: 12.5%;">4th Press</th> <th style="width: 12.5%;">5th Press</th> <th style="width: 12.5%;">6th Press</th> </tr> </thead> <tbody> <tr> <td>Temp indication</td> <td>-19℃ (Normal)</td> <td>-20℃</td> <td>-21℃</td> <td>-22℃ (Max)</td> <td>-16℃ (Min)</td> <td>-17℃</td> <td>-18℃</td> </tr> </tbody> </table> <p>3. "Super Freeze" Button</p> <p>When this mode is chosen, the icon (Super Freeze) is ON.</p> <p>4. "Refrigerator Set" button.</p> <ol style="list-style-type: none"> 1) Temperature control of Refrigerator compartment 2) 7 step mode of successive temperature mode. 3) Initial mode by power input : "4℃" <p>※ Whenever pressing button, setting is repeated in the order of (4℃) → (3℃) → (2℃) → (8℃) → (7℃) → (6℃) → (5℃).</p> <p>Letters are indicated on 88 Display LED</p> <table border="1" style="width: 100%; border-collapse: collapse; text-align: center;"> <thead> <tr> <th style="width: 12.5%;">Temperature Change</th> <th style="width: 12.5%;">Initially On</th> <th style="width: 12.5%;">1st Press</th> <th style="width: 12.5%;">2nd Press</th> <th style="width: 12.5%;">3th Press</th> <th style="width: 12.5%;">4th Press</th> <th style="width: 12.5%;">5th Press</th> <th style="width: 12.5%;">6th Press</th> </tr> </thead> <tbody> <tr> <td>Temp indication</td> <td>4℃ (Normal)</td> <td>3℃</td> <td>2℃ (Max)</td> <td>8℃ (Min)</td> <td>7℃</td> <td>6℃</td> <td>5℃</td> </tr> </tbody> </table> <p>5. "Super Cool" button.</p> <p>When this mode is chosen, the icon (Super Cool) is ON.</p> | | FCP-LED | Control | 88 Display (Set Temp.) | Initial mode : Freezer & Refrigerator set → Normal (-19℃/4℃) | Super Freeze , Super Cool Icon | Dial | FUZZY,DEODOR LED | ON | Temperature Change | Initially On | 1st Press | 2nd Press | 3th Press | 4th Press | 5th Press | 6th Press | Temp indication | -19℃ (Normal) | -20℃ | -21℃ | -22℃ (Max) | -16℃ (Min) | -17℃ | -18℃ | Temperature Change | Initially On | 1st Press | 2nd Press | 3th Press | 4th Press | 5th Press | 6th Press | Temp indication | 4℃ (Normal) | 3℃ | 2℃ (Max) | 8℃ (Min) | 7℃ | 6℃ | 5℃ |
| FCP-LED | Control | | | | | | | | | | | | | | | | | | | | | | | | | | | | | | | | | | | | | | | | |
| 88 Display (Set Temp.) | Initial mode : Freezer & Refrigerator set → Normal (-19℃/4℃) | | | | | | | | | | | | | | | | | | | | | | | | | | | | | | | | | | | | | | | | |
| Super Freeze , Super Cool Icon | Dial | | | | | | | | | | | | | | | | | | | | | | | | | | | | | | | | | | | | | | | | |
| FUZZY,DEODOR LED | ON | | | | | | | | | | | | | | | | | | | | | | | | | | | | | | | | | | | | | | | | |
| Temperature Change | Initially On | 1st Press | 2nd Press | 3th Press | 4th Press | 5th Press | 6th Press | | | | | | | | | | | | | | | | | | | | | | | | | | | | | | | | | | |
| Temp indication | -19℃ (Normal) | -20℃ | -21℃ | -22℃ (Max) | -16℃ (Min) | -17℃ | -18℃ | | | | | | | | | | | | | | | | | | | | | | | | | | | | | | | | | | |
| Temperature Change | Initially On | 1st Press | 2nd Press | 3th Press | 4th Press | 5th Press | 6th Press | | | | | | | | | | | | | | | | | | | | | | | | | | | | | | | | | | |
| Temp indication | 4℃ (Normal) | 3℃ | 2℃ (Max) | 8℃ (Min) | 7℃ | 6℃ | 5℃ | | | | | | | | | | | | | | | | | | | | | | | | | | | | | | | | | | |

4-1-3. Dispenser Model

| INPUT | CONTROL OBJECT |
|--|----------------|
| Front PCB button FREEZER SET, REFRIGERATOR SET SUPER FREEZER, SUPER REFRIGERATOR RESET FILTER, WATER / ICE, ICE MAKER LOCK ,LOCK | FCP C-LED |

| CONTENTS | REMARKS |
|----------|---------|
|----------|---------|

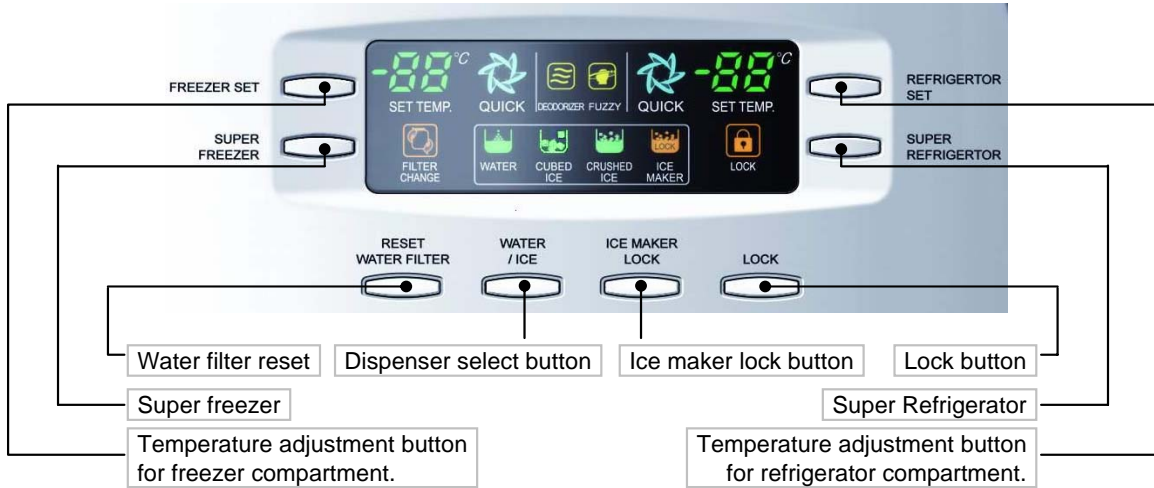

1. Display control

| FCP-LED | Control |
|---|--|
| 88 DISPLAY (SET TEMP.) | Initial mode : Freezer & Refrigerator set→ Medium (-19℃/4℃) |
| SUPER FREEZER, SUPER REFRIGERATOR ICON | Dial |
| FUZZY, DEODORIZER ICON | Always ON |
| WATER / CUBED ICE/ CRUSHED ICE ICON | Dial |
| LOCK ICON | Dial |
| ICE MAKER LOCK ICON | Dial |
| FILTER CHANGE ICON | After six month, LED ON |

2. "FREEZER SET" Button

- 1) Temperature control of freezer compartment
- 2) 7 step mode of successive temperature mode.
- 3) Initial mode by power input : "Medium(-19℃)"
 ※ Whenever pressing button, setting is repeated in the order of
 Medium (-19℃) → Medium Max 1 (-20℃) → Medium Max 2 (-21℃) → Max (-22℃)
 → Min (-16℃) → Medium Min 2 (-17℃) → Medium Min 2 (-18℃).

Letters are indicated on 88 Display LED

| | | | | | | | |
|--------------------|------|--------------|--------------|--------|--------------|--------------|------|
| Temperature Change | Min | Medium Min 1 | Medium Min 2 | Medium | Medium Max 1 | Medium Max 2 | Max |
| Temp indication | -16℃ | -17℃ | -18℃ | -19℃ | -20℃ | -21℃ | -22℃ |

3. "SUPER FREEZER" Button

When this mode is chosen, the icon (FREEZER QUICK) is ON.

| CONTENTS | REMARKS | | | | | | | | | | | | |
|--|--------------------|------------|------------|------------|------------|-----|-----------------|----|----|----|----|----|--|
| <p>4. "REFRIGERATOR SET" button.</p> <p>1) Temperature control of Refrigerator compartment</p> <p>2) 5 step mode of successive temperature mode.</p> <p>3) Initial mode by power input : "Medium (4℃)"</p> <p>※ Whenever pressing button, setting is repeated in the order of Medium (4℃) → Medium Max (3℃) → Max (2℃) → Min (6℃) → Medium Min (5℃).</p> <p>Letters are indicated on 88 Display LED</p> <table border="1" style="width: 100%; border-collapse: collapse; text-align: center;"> <tr> <td style="width: 20%;">Temperature Change</td> <td style="width: 15%;">Min</td> <td style="width: 15%;">Medium Min</td> <td style="width: 15%;">Mid</td> <td style="width: 15%;">Medium Max</td> <td style="width: 15%;">Max</td> </tr> <tr> <td>Temp indication</td> <td>6℃</td> <td>5℃</td> <td style="background-color: #ADD8E6;">4℃</td> <td>3℃</td> <td>2℃</td> </tr> </table> <p>5. "SUPER REFRIGERATOR" button.</p> <p>When this mode is chosen, the icon (REFRIGERATOR QUICK) is ON.</p> <p>6. "WATER / ICE" button</p> <p>1) Select Water / Cubed Ice / Crushed Ice.</p> <p>2) Icon lights up to show your selection is on. Initial mode by power input : "Water" mode.</p> <p>3) The mode of Cubed Ice or Crushed Ice continues for 1 hour and then changes to Water. (Water icon turns ON)</p> <p>7. "ICE MAKER LOCK" button</p> <p>1) Start by pushing "ICE MAKER LOCK" button</p> <p style="margin-left: 20px;">① "ICE MAKER LOCK" icon is on</p> <p style="margin-left: 20px;">② "WATER" icon is always on</p> <p>2) Stop by pushing "ICE MAKER LOCK" button again</p> <p style="margin-left: 20px;">① "ICE MAKER LOCK" icon is off</p> <p style="margin-left: 20px;">② "WATER" icon is on</p> <p>8. "RESET WATER FILTER" button</p> <p>1) The normal (ICON OFF) is on for 6 month after are first power input.</p> <p>2) After six months, icon is ON.</p> <p>3) How to reset Filter information</p> <p style="margin-left: 20px;">① Push the "RESET WATER FILTER" button for 3 seconds after change.</p> <p>9. "LOCK" button</p> <p>1) This button stops operation of different button.</p> <p style="margin-left: 20px;">① "LOCK" icon is on</p> <p style="margin-left: 20px;">② Press this button to lock out this case and to keep temperature and function setting.</p> <p>2) Push "LOCK" button again for more than a second to stop it.</p> <p>※ The actual inner temperature varies depending on the food status, as the indicated setting temperature is a target temperature, not actual temperature within refrigerator.</p> <p>※ Refrigeration function is weak in the initial time. Please adjust temperature as above after using refrigerator for minimum 2~3 days.</p> | Temperature Change | Min | Medium Min | Mid | Medium Max | Max | Temp indication | 6℃ | 5℃ | 4℃ | 3℃ | 2℃ | <p>REFERENCE : Please wait for 2-3 seconds in order to take final ice or drops of water when taking out cup from the pressing switches after taking ice or water.</p> |
| Temperature Change | Min | Medium Min | Mid | Medium Max | Max | | | | | | | | |
| Temp indication | 6℃ | 5℃ | 4℃ | 3℃ | 2℃ | | | | | | | | |

4-2. Defrost Mode

| INPUT | CONTROL OBJECT | |
|---|--|---------|
| 1. Defrosting Cycle | 1. Comp 2. F-Fan 3. R-Fan 4. D-Heater | |
| CONTENTS | | REMARKS |
| <p>1. Defrost Mode</p> <div style="display: flex; align-items: flex-start;"> <div style="flex: 1;"> <pre> graph TD A[Pre-Cool] --> B[Heater Defrosting] B --> C[Pause] C --> D[Fan-Delay] </pre> </div> <div style="flex: 2; padding-left: 20px;"> <p>Pre-Cool 1) Time : 50 minutes 2) Comp , F-fan : ON R-fan : Control D-HTR : OFF 3) If F-sensor $\leq -27^{\circ}\text{C}$, then Pre-Cool becomes. OFF</p> <p>Heater Defrosting 1) Comp, F-fan, R-fan : OFF D-HTR : ON 2) Time limit 30 seconds : Heater is ON regardless of D-sensor temperature right after defrosting start 30 minutes : in case of D1- Error 80 minutes : in normal control state 3) If D-sensor $\geq 13^{\circ}\text{C}$, Heater Defrosting is OFF</p> <p>Pause Time : 7 minutes Comp, F-fan, R-fan, Heater etc. : OFF</p> <p>Fan-Delay Time : 5 minutes Comp : ON and F-fan, R-fan, Heater : OFF</p> </div> </div> <p>2.The defrost mode start with the following conditions</p> <ol style="list-style-type: none"> 1) Total operation time of comp. becomes : 6,8,10,..... 24 hours. <ol style="list-style-type: none"> ① Comp. operating rate : more 85% ② Total door open time : 2 minutes (Any door, F or R open time is over 2 minutes.) ③ Any error mode : R1, F1, D1, F3, RT/S, Door-switch etc.) 2) Defrosting mode starts unconditionally as long as total comp. work time is 24 hours, even if the above conditions 1) are not satisfied. 3) Defrosting mode starts immediately as long as total time of [comp. ON + comp. OFF] is over 60 hours, even if the above 1) and 2) conditions are not satisfied. <p>3. In providing initial power (or returning power failure)</p> <p style="padding-left: 20px;">If D-sensor temp. $\leq 3.5^{\circ}\text{C}$, defrosting mode starts .</p> | | |

| CONTENTS | REMARKS |
|----------|---------|
|----------|---------|

4. Flow Chart of Defrosting Start

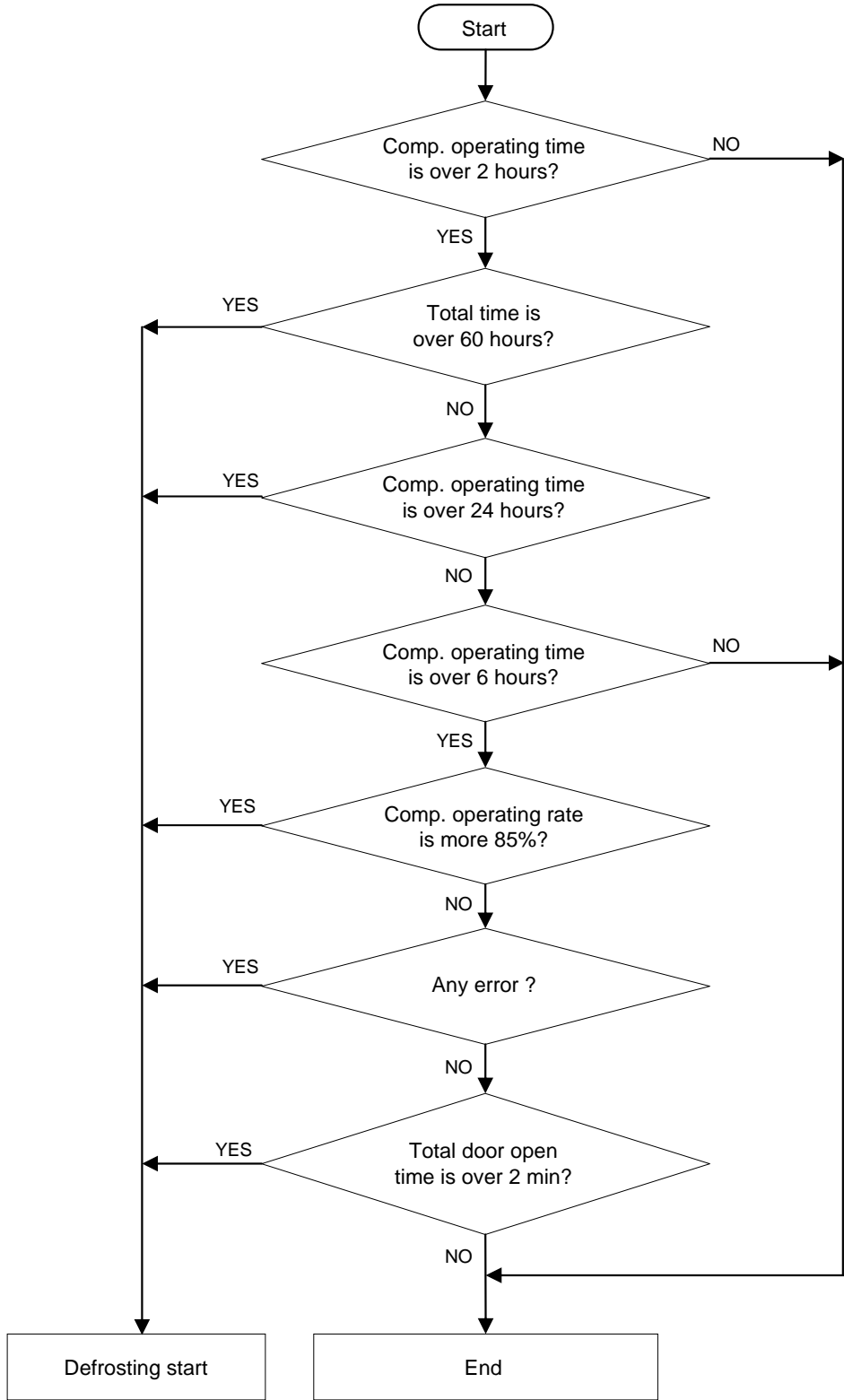

4-3. Forced Defrosting Mode

| INPUT | CONTROL OBJECT | |
|---|--|---------|
| 1. Defrosting Cycle | 1. Comp 2. F-Fan 3. R-Fan 4. D-Heater | |
| CONTENTS | | REMARKS |
| <p>1. A/S Defrosting Mode (Heater defrost → Pause → Fan Delay)</p> <div style="display: flex; align-items: flex-start;"> <div style="flex: 1;"> <pre> graph TD A[Heater Defrosting] --> B[Pause] B --> C[Fan-Delay] </pre> </div> <div style="flex: 2; padding-left: 20px;"> <p>Heater Defrosting</p> <p>1) Comp, F-fan, R-fan : OFF D-HTR : ON</p> <p>2) Time limit 30 seconds : Heater is ON regardless of D-sensor temperature right after defrosting start 30 minutes : in case of D1-Error 80 minutes : in normal control state</p> <p>3) If D-sensor $\geq 13^{\circ}\text{C}$, Heater Defrosting is OFF</p> <p>Pause</p> <p>Time : 7 minutes Comp, F-fan, R-fan, Heater etc. : OFF</p> <p>Fan-Delay</p> <p>1) Time : 5 minutes Comp : ON F-fan, R-fan, Heater : OFF</p> </div> </div> <p>2. How to start</p> <p>1) Basic Model Push "REF.TEMP (Set)" button 5 times while pushing "FRZ.TEMP (Set)" button simultaneously.</p> <p>2) Dispenser Model Push the 'LOCK' button. Push "REFRIGERATOR SET" button 5 times while pushing "FREEZER SET" button.</p> <p>3. How to proceed</p> <p>1) Delete Pre-cool mode. (Others are same as normal defrosting)</p> <p>2) Heater is ON regardless of D-sensor temp. at first 30 seconds. (Check of defrosting current)</p> | | |

4-4. Fan Voltage of Control Mode

| INPUT | CONTROL OBJECT | | | | | | | | | |
|---|------------------------|---------|-------|-------|-------|---------|------|------|------|--|
| 1. F-Sensor 2. R-Sensor | 1. F-FAN, R-FAN, C-FAN | | | | | | | | | |
| CONTENTS | | REMARKS | | | | | | | | |
| <p>1. Fan voltage of control mode</p> <table border="1" style="width: 100%; text-align: center;"> <thead> <tr> <th>FAN</th> <th>F-FAN</th> <th>R-FAN</th> <th>C-FAN</th> </tr> </thead> <tbody> <tr> <td>Voltage</td> <td>13 V</td> <td>13 V</td> <td>13 V</td> </tr> </tbody> </table> | | FAN | F-FAN | R-FAN | C-FAN | Voltage | 13 V | 13 V | 13 V | |
| FAN | F-FAN | R-FAN | C-FAN | | | | | | | |
| Voltage | 13 V | 13 V | 13 V | | | | | | | |

4-5. Buzzer or Alarm Control

| INPUT | CONTROL OBJECT | |
|---|----------------|---------|
| 1. Control (Inner or F-PCB) buttons 2. Door Switch 3. Initial Power Input | Buzzer | |
| CONTENTS | | REMARKS |
| 1. Buzzer sounds if any button of Inner Control is pushed. 2. Buzzer sounds 4 times 3 seconds after initial power input. 3. Buzzer sounds for 3 or 1 times in case of A/S forced defrosting and short (pull down) operation or explanation mode. 4. If door is open, buzzer sounds after every 1 minutes for 5 minutes (Door open alarm) | | |

4-6. Control of Interior Lights

| INPUT | CONTROL OBJECT | |
|--|----------------|---------|
| 1. Refrigerator door switch 2. Freezer door switch | Lamp | |
| CONTENTS | | REMARKS |
| 1. Control refrigerator compartment lights R-Lights turn ON/OFF by R-door switch ON/OFF (※ For 10 minutes after sensing door open, the lights turn off automatically through door close is not sensed.) 2. Control of freezer compartment lights. F-Light turn ON/OFF by F-door switch ON/OFF (※ For 10 minutes after sensing door open, the lights turn off automatically through door close is not sensed.) | | |

4-7. Demonstration Mode

4-7-1. FRS(N)-U20IE* Type

| INPUT | CONTROL OBJECT |
|--|------------------------|
| 1. FRZ. TEMP 2. Door Switch | F/R-Fan Door Switch |
| CONTENTS | |
| 1. Start Open and close "Refrigerator Door switch" 5 times while pushing "FRZ. TEMP" button simultaneously. 2. Control 1) All other electrical components are OFF except for F-fan / R-fan 2) Fan Control Door open → Fan ON / Door close → Fan OFF. 3) Display control "Freezer LED" and "Refrigerator LED" are ON in good order 3. Stop 1) During Demo mode, push "Refrigerator Door switch" open and close 5 times while pushing "FRZ. TEMP" button simultaneously. 2) Power in again | REMARKS |

4-7-2. FRS(N)-U20BE* Type

| INPUT | CONTROL OBJECT |
|--|------------------------|
| 1. FRZ. SET 2. SUPER REF. | F/R-Fan Door Switch |
| CONTENTS | |
| 1. Start Push "SUPER REF." button 5 times while pushing "REF. SET" button simultaneously. 2. Control 1) All other electrical components are OFF except for F-fan / R-fan 2) Fan Control Door open → Fan ON / Door close → Fan OFF. 3) Display control "Freezer LED" and "Refrigerator LED" are ON in good order 3. Stop 1) During Demo mode, push "SUPER REF" button 5 times while pushing "REF. SET" button simultaneously. 2) Power in again | REMARKS |

4-7-3. Dispenser Model

| INPUT | CONTROL OBJECT |
|---|------------------------|
| "REFRIGEATOR SET, WATER/ICE" Button | F/R-Fan Door Switch |
| CONTENTS | |
| <p>1. Start</p> <p>1-1. Push the "LOCK" button.</p> <p>1-2. Push "ICE/WATER" button 5 times while pushing "REFRIGERATOR SET" button simultaneously.</p> <p>2. Control</p> <p>1) All other electrical components are OFF except for F-fan / R-fan</p> <p>2) Fan Control Door OPEN → Fan ON / Door close → Fan OFF.</p> <p>3. Stop or termination</p> <p>1) During Demo mode, push "ICE/WATER" button 5 times while pushing "FREEZER SET" button simultaneously.</p> <p>2) Power in again</p> | REMARKS |



4-8. Compensation of R-sensor ON/OFF Temp.

| INPUT | CONTROL OBJECT |
|----------|--|
| Main PCB | Resistance of R-sensor ON/OFF Temp. of Refrigerator |

CONTENTS

Compensation of R-sensor ON/OFF temp. (down)

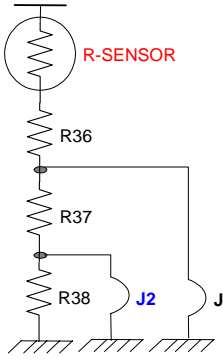
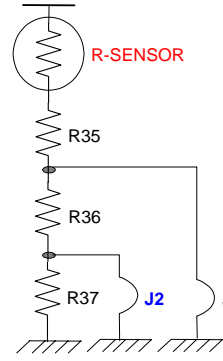
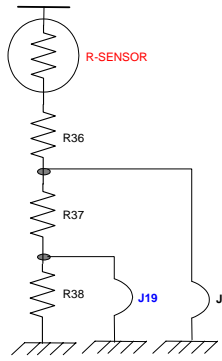
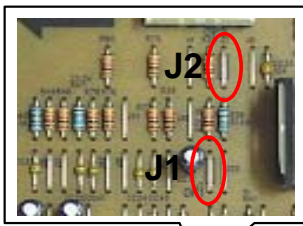
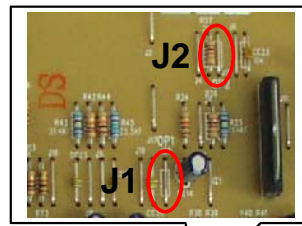
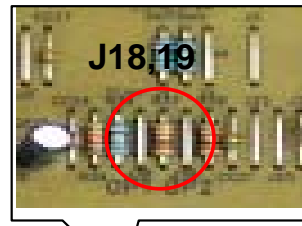
In case temperature of refrigerator compartment is weak or insufficient, take the following action.

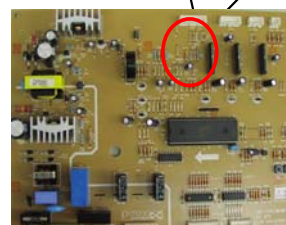
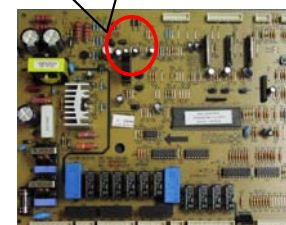
| FRS(N)-U20IE* | FRS(N)-U20BE* | Dispenser Model |
|---|---|---|
|  |  |  |
|  |  |  |
|  |  |  |

※ R-SENSOR standard resistance in normal mode (31.4K)

- (1) In case of weak ref., cut J1 (or J18) to down the standard resistance by 1.5deg(2K)
- (2) In case of weak ref., cut J2 (or J19) to down the standard resistance by 1.5deg(2K)

| | | | | | |
|--------------------------|-----------------|-----|-------|-----|-----|
| M o d e l | FRS(N)-U20IE* | J1 | - | cut | cut |
| | | J2 | - | - | cut |
| | FRS(N)-U20BE* | J1 | - | cut | cut |
| | | J2 | - | - | cut |
| | Dispenser Model | J18 | - | cut | cut |
| | | J19 | - | - | cut |
| Temperature compensation | | 0℃ | -1.5℃ | 3℃ | |

4-9. Error Display

4-9-1. FRS(N)-U20IE* Type

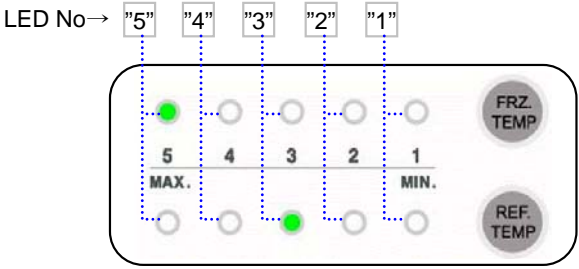
| INPUT | CONTROL OBJECT | | | | | | | | | | | | | | | | | | | | | | | | | |
|---|------------------------------------|----------|---------|--------------------------------------|----------------------------|--------------------------------------|----------------------------|---------------------------------------|----------------------------|--------------------------------------|----------------------------|---------------------------|----------------------------|---------------------------|----------------------------|-------------------|----------------------------|-------------------------------------|----------------------------|--------------------|----------------------------|----------------|--------------------|-----------------------------|------------------------------------|--|
| Temperature Control Buttons | Lamp LED of Inner control | | | | | | | | | | | | | | | | | | | | | | | | | |
| CONTENTS | | REMARKS | | | | | | | | | | | | | | | | | | | | | | | | |
| <p>1. How to start</p> <p>1) Press "FRZ.TEMP" button 5 times while pressing "REF.TEMP" button at the same time.</p> <p>2. How to stop</p> <p>1) Push "FRZ.TEMP" button 1 time.</p> <p>2) It stops automatically in 4 minutes from the start.</p> <p>3. All the error codes are reset if they turn to be normal.</p> <p>4. Error display</p> <table border="1" data-bbox="153 987 1217 1570"> <thead> <tr> <th>CONTENTS</th> <th>Display</th> </tr> </thead> <tbody> <tr> <td>F-sensor : open ("Lo"), short ("Hi")</td> <td>FRZ. LED "5" is on and off</td> </tr> <tr> <td>R-sensor : open ("Lo"), short ("Hi")</td> <td>FRZ. LED "4" is on and off</td> </tr> <tr> <td>RT-sensor : open ("Lo"), short ("Hi")</td> <td>FRZ. LED "3" is on and off</td> </tr> <tr> <td>D-sensor : open ("Lo"), short ("Hi")</td> <td>FRZ. LED "2" is on and off</td> </tr> <tr> <td>R-Door Switch : defective</td> <td>FRZ. LED "1" is on and off</td> </tr> <tr> <td>F-Door Switch : defective</td> <td>REF. LED "5" is on and off</td> </tr> <tr> <td>Cycle : defective</td> <td>REF. LED "3" is on and off</td> </tr> <tr> <td>Return after defrosting : defective</td> <td>REF. LED "2" is on and off</td> </tr> <tr> <td>EEPROM : defective</td> <td>REF. LED "1" is on and off</td> </tr> <tr> <td>Full Down mode</td> <td>REF. LED "1" is on</td> </tr> <tr> <td>Forced defrost mode for A/S</td> <td>REF. LED "1" is on and off (twice)</td> </tr> </tbody> </table> <p>(Full down mode and forced defrost mode are displayed while pressing "REF.TEMP" button at the error display mode)</p>  | | CONTENTS | Display | F-sensor : open ("Lo"), short ("Hi") | FRZ. LED "5" is on and off | R-sensor : open ("Lo"), short ("Hi") | FRZ. LED "4" is on and off | RT-sensor : open ("Lo"), short ("Hi") | FRZ. LED "3" is on and off | D-sensor : open ("Lo"), short ("Hi") | FRZ. LED "2" is on and off | R-Door Switch : defective | FRZ. LED "1" is on and off | F-Door Switch : defective | REF. LED "5" is on and off | Cycle : defective | REF. LED "3" is on and off | Return after defrosting : defective | REF. LED "2" is on and off | EEPROM : defective | REF. LED "1" is on and off | Full Down mode | REF. LED "1" is on | Forced defrost mode for A/S | REF. LED "1" is on and off (twice) | |
| CONTENTS | Display | | | | | | | | | | | | | | | | | | | | | | | | | |
| F-sensor : open ("Lo"), short ("Hi") | FRZ. LED "5" is on and off | | | | | | | | | | | | | | | | | | | | | | | | | |
| R-sensor : open ("Lo"), short ("Hi") | FRZ. LED "4" is on and off | | | | | | | | | | | | | | | | | | | | | | | | | |
| RT-sensor : open ("Lo"), short ("Hi") | FRZ. LED "3" is on and off | | | | | | | | | | | | | | | | | | | | | | | | | |
| D-sensor : open ("Lo"), short ("Hi") | FRZ. LED "2" is on and off | | | | | | | | | | | | | | | | | | | | | | | | | |
| R-Door Switch : defective | FRZ. LED "1" is on and off | | | | | | | | | | | | | | | | | | | | | | | | | |
| F-Door Switch : defective | REF. LED "5" is on and off | | | | | | | | | | | | | | | | | | | | | | | | | |
| Cycle : defective | REF. LED "3" is on and off | | | | | | | | | | | | | | | | | | | | | | | | | |
| Return after defrosting : defective | REF. LED "2" is on and off | | | | | | | | | | | | | | | | | | | | | | | | | |
| EEPROM : defective | REF. LED "1" is on and off | | | | | | | | | | | | | | | | | | | | | | | | | |
| Full Down mode | REF. LED "1" is on | | | | | | | | | | | | | | | | | | | | | | | | | |
| Forced defrost mode for A/S | REF. LED "1" is on and off (twice) | | | | | | | | | | | | | | | | | | | | | | | | | |

4-9-2. FRS(N)-U20BE* Type

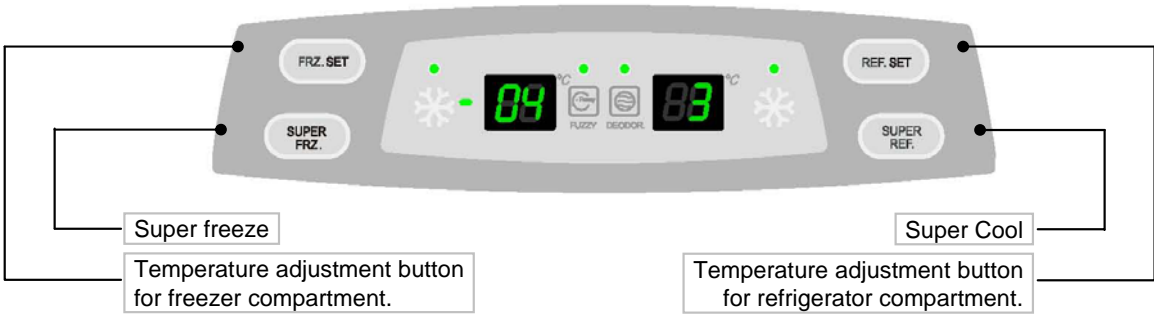
| INPUT | CONTROL OBJECT | | | | | | | | | | | | | | | | | | | | | |
|---|---|------------|----------|-----------|---|-----------|---|-----------|--|-----------|---|-----------|---------------------------|-----------|---------------------------|-----------|-------------------------------|-----------|---|-----------|-------------------------------------|--|
| Temperature Control Buttons | 88 Display CLED | | | | | | | | | | | | | | | | | | | | | |
| CONTENTS | | REMARKS | | | | | | | | | | | | | | | | | | | | |
| <p>1. How to start</p> <ol style="list-style-type: none"> 1) Press "SUPER FRZ." button 5 times while pressing "FRZ. SET" button at the same time. 2) The front LED displays as the right diagram shows ([Ex.] Time Display of 0003 signifies 3 minutes of power on time.) 3) Press "FRZ. SET" button and the following value is displayed successively. <ol style="list-style-type: none"> ① Time ② F-Sensor temperature ③ D-Sensor temperature ④ R-Sensor temperature ⑤ RT-Sensor temperature 4) Error is displayed only if there is any ; it is skipped if no error. <p>2. How to stop</p> <ol style="list-style-type: none"> 1) Push "REF. SET" button 1 time. 2) It stops automatically in 4 minutes from the start. <p>3. All the error codes are reset if they turn to be normal.</p> <p>4. Error code</p> | | | | | | | | | | | | | | | | | | | | | | |
| <table border="1" data-bbox="175 1070 1134 1550"> <thead> <tr> <th>ERROR CODE</th> <th>CONTENTS</th> </tr> </thead> <tbody> <tr> <td><i>F1</i></td> <td>F-sensor : disconnection ("Lo"), short ("Hi")</td> </tr> <tr> <td><i>r1</i></td> <td>R-sensor : disconnection ("Lo"), short ("Hi")</td> </tr> <tr> <td><i>rt</i></td> <td>RT-sensor : disconnection ("Lo"), short ("Hi")</td> </tr> <tr> <td><i>d1</i></td> <td>D-sensor : disconnection ("Lo"), short ("Hi")</td> </tr> <tr> <td><i>dr</i></td> <td>R-Door Switch : defective</td> </tr> <tr> <td><i>dF</i></td> <td>F-Door Switch : defective</td> </tr> <tr> <td><i>C1</i></td> <td>Cycle : abnormal or defective</td> </tr> <tr> <td><i>F3</i></td> <td>Return after defrosting : abnormal or defective</td> </tr> <tr> <td><i>D2</i></td> <td>Display forced defrost mode for A/S</td> </tr> </tbody> </table> | | ERROR CODE | CONTENTS | <i>F1</i> | F-sensor : disconnection ("Lo"), short ("Hi") | <i>r1</i> | R-sensor : disconnection ("Lo"), short ("Hi") | <i>rt</i> | RT-sensor : disconnection ("Lo"), short ("Hi") | <i>d1</i> | D-sensor : disconnection ("Lo"), short ("Hi") | <i>dr</i> | R-Door Switch : defective | <i>dF</i> | F-Door Switch : defective | <i>C1</i> | Cycle : abnormal or defective | <i>F3</i> | Return after defrosting : abnormal or defective | <i>D2</i> | Display forced defrost mode for A/S | |
| ERROR CODE | CONTENTS | | | | | | | | | | | | | | | | | | | | | |
| <i>F1</i> | F-sensor : disconnection ("Lo"), short ("Hi") | | | | | | | | | | | | | | | | | | | | | |
| <i>r1</i> | R-sensor : disconnection ("Lo"), short ("Hi") | | | | | | | | | | | | | | | | | | | | | |
| <i>rt</i> | RT-sensor : disconnection ("Lo"), short ("Hi") | | | | | | | | | | | | | | | | | | | | | |
| <i>d1</i> | D-sensor : disconnection ("Lo"), short ("Hi") | | | | | | | | | | | | | | | | | | | | | |
| <i>dr</i> | R-Door Switch : defective | | | | | | | | | | | | | | | | | | | | | |
| <i>dF</i> | F-Door Switch : defective | | | | | | | | | | | | | | | | | | | | | |
| <i>C1</i> | Cycle : abnormal or defective | | | | | | | | | | | | | | | | | | | | | |
| <i>F3</i> | Return after defrosting : abnormal or defective | | | | | | | | | | | | | | | | | | | | | |
| <i>D2</i> | Display forced defrost mode for A/S | | | | | | | | | | | | | | | | | | | | | |
|  | | | | | | | | | | | | | | | | | | | | | | |

| CONTENTS | REMARKS | | | | | | | | | | | | | | | | | | | | | | | | | | | | |
|---|---------|---------|---------|---------|---------|----------|----------|--------------|---------|---------|---------|---------|---------|---------|------|------|-------|-------|-------|-------|----------|--------------|-----|--------|--------|-------|-------|-------|--|
| <p>5. Control way of Errors (if any)</p> <p>1) "F-sensor" error Cause : F-sensor open or short Control : Condition of ambient temperature How to reset : If F-sensor is normal, the error is terminal temperature.</p> <table border="1" style="width: 100%; border-collapse: collapse; text-align: center;"> <tr> <td>RT-S</td> <td>~ 9℃</td> <td>~ 15℃</td> <td>~ 21℃</td> <td>~ 31℃</td> <td>~ 41℃</td> <td>Over 41℃</td> </tr> <tr> <td>ON/OFF (min)</td> <td>14 / 50</td> <td>16 / 41</td> <td>27 / 45</td> <td>26 / 22</td> <td>35 / 20</td> <td>35 / 20</td> </tr> </table> <p>2) "R-sensor" error Cause : R-sensor open or short Control : Condition of ambient temperature How to reset : If R-sensor is normal, the error is terminal temperature.</p> <table border="1" style="width: 100%; border-collapse: collapse; text-align: center;"> <tr> <td>RT-S</td> <td>~ 9℃</td> <td>~ 15℃</td> <td>~ 21℃</td> <td>~ 31℃</td> <td>~ 41℃</td> <td>Over 41℃</td> </tr> <tr> <td>ON/OFF (min)</td> <td>OFF</td> <td>3 / 50</td> <td>2 / 10</td> <td>3 / 7</td> <td>4 / 6</td> <td>6 / 4</td> </tr> </table> <p>3) "RT-sensor" error Cause : RT-sensor open or short (full down) Control : Normal operation, deletion of control by RT-sensor If RT-sensor is normal, the error is terminated automatically.</p> <p>4) "D-sensor" error Cause : D-sensor open or short (full down) Control : Time limit (30 min) of defrosting return If D-sensor is normal, the error is terminated automatically.</p> <p>5) "Door" error Cause : in case it senses that door is open for more than 1 hour. Control : Deletion of function related door switch sensing If door switch (open & close) is sensed, the error is terminated automatically.</p> <p>6) "Cycle" error Cause : in case comp. works for over 3 hours when D-sensor temp. is over -5℃ Control : normal operation When D-sensor temp. is below -5℃ in comp. off it is terminated.</p> <p>7) "Return after defrosting" error Cause : in case defrosting return is done by time limit of 80 min Control : Deletion of Pre-cool mode in defrosting mode If defrosting return is done by D-sensor, it is terminated.</p> <p>8) A/S forced defrosting mode Push "REFRIGERATOR SET" button 5 times while pushing "FREEZER SET" button Simultaneously. Control : A/S forced defrosting control (Pre-cool is deleted) If D-sensor temp. is over 10℃, the mode is terminated automatically. When all error code is normal, the Refrigerator reset</p> | RT-S | ~ 9℃ | ~ 15℃ | ~ 21℃ | ~ 31℃ | ~ 41℃ | Over 41℃ | ON/OFF (min) | 14 / 50 | 16 / 41 | 27 / 45 | 26 / 22 | 35 / 20 | 35 / 20 | RT-S | ~ 9℃ | ~ 15℃ | ~ 21℃ | ~ 31℃ | ~ 41℃ | Over 41℃ | ON/OFF (min) | OFF | 3 / 50 | 2 / 10 | 3 / 7 | 4 / 6 | 6 / 4 | |
| RT-S | ~ 9℃ | ~ 15℃ | ~ 21℃ | ~ 31℃ | ~ 41℃ | Over 41℃ | | | | | | | | | | | | | | | | | | | | | | | |
| ON/OFF (min) | 14 / 50 | 16 / 41 | 27 / 45 | 26 / 22 | 35 / 20 | 35 / 20 | | | | | | | | | | | | | | | | | | | | | | | |
| RT-S | ~ 9℃ | ~ 15℃ | ~ 21℃ | ~ 31℃ | ~ 41℃ | Over 41℃ | | | | | | | | | | | | | | | | | | | | | | | |
| ON/OFF (min) | OFF | 3 / 50 | 2 / 10 | 3 / 7 | 4 / 6 | 6 / 4 | | | | | | | | | | | | | | | | | | | | | | | |

4-9-3. Dispenser Model

| INPUT | CONTROL OBJECT | | | | | | | | | | | | | | | | | | | | | | | | | | | | | | | | | | | | | | | |
|---|---|------------|----------|-----------|---|-----------|---|-----------|--|-----------|---|-----------|---------------------------|-----------|---------------------------|-----------|----------------------------------|-----------|---|-----------|-------------------------|-----------|---------------------------|-----------|----------------------|-----------|----------------------|-----------|-----------------------|-----------|-------------------------|-----------|-------------------------------|-----------|---|-----------|------------------------|-----------|-------------------------------------|--|
| Temperature Control Buttons | 88 Display CLED | | | | | | | | | | | | | | | | | | | | | | | | | | | | | | | | | | | | | | | |
| CONTENTS | | REMARKS | | | | | | | | | | | | | | | | | | | | | | | | | | | | | | | | | | | | | | |
| <p>1. How to start</p> <p>1) Under "LOCK" mode, press "SUPER FREEZER" button 5 times while pressing "FREEZER SET" button at the same time.</p> <p>2) The front CLED displays as the right diagram shows ([Ex.] Time Display of 0003 signifies 3 minutes of power on time.)</p> <p>3) Press "FREEZER SET" button and the following value is displayed successively.</p> <p>① Time</p> <p>② F-Sensor temperature</p> <p>③ D-Sensor temperature</p> <p>④ R-Sensor temperature</p> <p>⑤ RT-Sensor temperature</p> <p>⑥ P Factor display (Refer to water supply mode of automatic icemaker)</p> <p>⑦ Filter remaining time until change (First check ; 4,320Hr) Refer to Filter Information Reset of CLED of front control panel.</p> <p>4) Error is displayed only if there is any ; it is skipped if no error.</p> <p>2. How to stop</p> <p>1) Push "LOCK" button 1 time.</p> <p>2) It stops automatically in 4 minutes from the start.</p> <p>3. All the error Codes are reset if they turn to be normal.</p> <p>4. Error code</p> <table border="1" style="width: 100%; border-collapse: collapse;"> <thead> <tr> <th style="width: 20%;">ERROR CODE</th> <th>CONTENTS</th> </tr> </thead> <tbody> <tr><td><i>F1</i></td><td>F-sensor : disconnection ("Lo"), short ("Hi")</td></tr> <tr><td><i>r1</i></td><td>R-sensor : disconnection ("Lo"), short ("Hi")</td></tr> <tr><td><i>rt</i></td><td>RT-sensor : disconnection ("Lo"), short ("Hi")</td></tr> <tr><td><i>d1</i></td><td>D-sensor : disconnection ("Lo"), short ("Hi")</td></tr> <tr><td><i>dr</i></td><td>R-Door Switch : defective</td></tr> <tr><td><i>dF</i></td><td>F-Door Switch : defective</td></tr> <tr><td><i>dH</i></td><td>Home bar Door Switch : defective</td></tr> <tr><td><i>El</i></td><td>l-sensor : disconnection ("Lo"), short ("Hi")</td></tr> <tr><td><i>EF</i></td><td>Flow sensor : defective</td></tr> <tr><td><i>Et</i></td><td>Horizontal switch : error</td></tr> <tr><td><i>Eg</i></td><td>Water supply : error</td></tr> <tr><td><i>ES</i></td><td>Micro switch : error</td></tr> <tr><td><i>EA</i></td><td>Drop the ice while Et</td></tr> <tr><td><i>Eu</i></td><td>Full ice switch : error</td></tr> <tr><td><i>C1</i></td><td>Cycle : abnormal or defective</td></tr> <tr><td><i>F3</i></td><td>Return after defrosting : abnormal or defective</td></tr> <tr><td><i>Co</i></td><td>Display Full Down mode</td></tr> <tr><td><i>D2</i></td><td>Display forced defrost mode for A/S</td></tr> </tbody> </table> | | ERROR CODE | CONTENTS | <i>F1</i> | F-sensor : disconnection ("Lo"), short ("Hi") | <i>r1</i> | R-sensor : disconnection ("Lo"), short ("Hi") | <i>rt</i> | RT-sensor : disconnection ("Lo"), short ("Hi") | <i>d1</i> | D-sensor : disconnection ("Lo"), short ("Hi") | <i>dr</i> | R-Door Switch : defective | <i>dF</i> | F-Door Switch : defective | <i>dH</i> | Home bar Door Switch : defective | <i>El</i> | l-sensor : disconnection ("Lo"), short ("Hi") | <i>EF</i> | Flow sensor : defective | <i>Et</i> | Horizontal switch : error | <i>Eg</i> | Water supply : error | <i>ES</i> | Micro switch : error | <i>EA</i> | Drop the ice while Et | <i>Eu</i> | Full ice switch : error | <i>C1</i> | Cycle : abnormal or defective | <i>F3</i> | Return after defrosting : abnormal or defective | <i>Co</i> | Display Full Down mode | <i>D2</i> | Display forced defrost mode for A/S | |
| ERROR CODE | CONTENTS | | | | | | | | | | | | | | | | | | | | | | | | | | | | | | | | | | | | | | | |
| <i>F1</i> | F-sensor : disconnection ("Lo"), short ("Hi") | | | | | | | | | | | | | | | | | | | | | | | | | | | | | | | | | | | | | | | |
| <i>r1</i> | R-sensor : disconnection ("Lo"), short ("Hi") | | | | | | | | | | | | | | | | | | | | | | | | | | | | | | | | | | | | | | | |
| <i>rt</i> | RT-sensor : disconnection ("Lo"), short ("Hi") | | | | | | | | | | | | | | | | | | | | | | | | | | | | | | | | | | | | | | | |
| <i>d1</i> | D-sensor : disconnection ("Lo"), short ("Hi") | | | | | | | | | | | | | | | | | | | | | | | | | | | | | | | | | | | | | | | |
| <i>dr</i> | R-Door Switch : defective | | | | | | | | | | | | | | | | | | | | | | | | | | | | | | | | | | | | | | | |
| <i>dF</i> | F-Door Switch : defective | | | | | | | | | | | | | | | | | | | | | | | | | | | | | | | | | | | | | | | |
| <i>dH</i> | Home bar Door Switch : defective | | | | | | | | | | | | | | | | | | | | | | | | | | | | | | | | | | | | | | | |
| <i>El</i> | l-sensor : disconnection ("Lo"), short ("Hi") | | | | | | | | | | | | | | | | | | | | | | | | | | | | | | | | | | | | | | | |
| <i>EF</i> | Flow sensor : defective | | | | | | | | | | | | | | | | | | | | | | | | | | | | | | | | | | | | | | | |
| <i>Et</i> | Horizontal switch : error | | | | | | | | | | | | | | | | | | | | | | | | | | | | | | | | | | | | | | | |
| <i>Eg</i> | Water supply : error | | | | | | | | | | | | | | | | | | | | | | | | | | | | | | | | | | | | | | | |
| <i>ES</i> | Micro switch : error | | | | | | | | | | | | | | | | | | | | | | | | | | | | | | | | | | | | | | | |
| <i>EA</i> | Drop the ice while Et | | | | | | | | | | | | | | | | | | | | | | | | | | | | | | | | | | | | | | | |
| <i>Eu</i> | Full ice switch : error | | | | | | | | | | | | | | | | | | | | | | | | | | | | | | | | | | | | | | | |
| <i>C1</i> | Cycle : abnormal or defective | | | | | | | | | | | | | | | | | | | | | | | | | | | | | | | | | | | | | | | |
| <i>F3</i> | Return after defrosting : abnormal or defective | | | | | | | | | | | | | | | | | | | | | | | | | | | | | | | | | | | | | | | |
| <i>Co</i> | Display Full Down mode | | | | | | | | | | | | | | | | | | | | | | | | | | | | | | | | | | | | | | | |
| <i>D2</i> | Display forced defrost mode for A/S | | | | | | | | | | | | | | | | | | | | | | | | | | | | | | | | | | | | | | | |

| CONTENTS | REMARKS |
|--|---------|
| <p>5. Control way of Error (if any)</p> <p>1) "F1" error Cause : F-sensor disconnection or short Check point : Measure the resistance between both terminals after separating CN8 (or CN15) of the Main PCB. (Refer to the 5-2.) If F-sensor is disconnected or shorted , change the F-sensor in the freezer compartment. How to reset : If F-sensor is normal, the error is terminal temperature.</p> <p>2) "R1" error Cause : R-sensor disconnection or short Check point : Measure the resistance between both terminals after separating CN7 (or CN14) of the Main PCB. (Refer to the 5-2.) If R-sensor is disconnected or shorted , change the F-sensor in the refrigerator compartment. How to reset : If R-sensor is normal, the error is terminal temperature.</p> <p>3) "rt" error Cause : RT-sensor disconnection or short (full down) Check point : Measure the voltage of "A" part on the Main PCB. If the voltage is 0.5V~4.5V, it is normal. If the voltage is 0V (short) or 5V (disconnected), change the RT-sensor on the Main PCB How to reset : If RT-sensor is normal, the error is terminated automatically.</p> <div style="display: flex; justify-content: space-around;"> <div data-bbox="172 969 699 1120"> </div> <div data-bbox="708 969 1182 1120"> </div> </div> <p style="text-align: center;">< Basic Model > < Dispenser Model ></p> <p>4) "d1" error Cause : D-sensor disconnection or short (full down) Check point : Measure the resistance between both terminals after separating CN8 (or CN15) of the Main PCB. (Refer to the 5-2.) If D-sensor is disconnected or shorted , change the D-sensor on the evaporator. How to reset : If D-sensor is normal, the error is terminated automatically.</p> <p>5) Door error ("dF" "dR" "dH" on display) Cause : in case it senses that door is open for more than 1 hour. Check point : F/R door is opened or not.</p> <p>6) "C1" error Cause : in case comp. works for over 3 hours when D-sensor temp. is over -5℃ Check point : Refrigerant leakage.</p> <p>7) "F3" error Cause : in case defrosting return is done by time limit of 80 min Check point : Measure the resistance between both terminals of the defrost heater. (Assembled with evaporator) If the resistance is ∞Ω (disconnected) or 0Ω (short) change the</p> <p>8) "d2" mode (A/S forced defrosting mode) Push "REFRIGERATOR SET" button 5 times while pushing "FREEZER SET" button simultaneously. Control : A/S forced defrosting control (Pre-cool is deleted) If D-sensor temp. is over 10℃, the mode is terminated automatically. Refer to the 4-3. .</p> | |

| CONTENTS | REMARKS |
|--|---------|
| <p>9) "EI"ERROR Cause : I-SENSOR disconnection / short Check point : Measure the resistance between both terminals after separating CN11 of the Main PCB. (Refer to the 5-2.) If F-sensor is disconnected or shorted , change the I-sensor in the automatic ice maker.</p> <p>10) "EF" ERROR Cause : When Flow-sensor ERROR (There is no Pulse during some time) The number of pulse signal is below 10 by 1 sec during water supply. Check point : Water supply line</p> <p>11) "Eg" ERROR Cause : I-sensor temp (5min after water supply) doesn't go up. Check the I-sensor or water supply line.</p> <p>12) "ES" error (MICRO switch error) Cause : When it senses 1min continuously Check the MICRO switch of the dispenser.</p> <p>13) "Ea" error Cause : Malfunction of ice drop motor. Check the motor by pushing test switch.</p> <p>14) "Eu" error Cause : Switch (which senses if the ice is full or not) is in error. Control : When dropping the ice, the motor just rotates 90 degree. Termination : When the switch is in normal.</p> <p>15)"EA" ERROR Cause : When sensing Ice dropping by time 3 times in level sensor SW Error. Control : Stop of Ice Maker Termination : With normal level switch. Re-input of power or push if icemaker test switch.</p> <p>16)"Et" ERROR Cause : Level switch error (No pulse is sensed for some time) Control : By time (Supply mode is skipped) Termination : Normal condition.</p> <p>* When all ERROR CODE is normal, the Refrigerator reset</p> | |

4-10. Summary of Function

4-10-1. FRS(N)-20IE* Type

| INPUT | | CONTROL OBJECT | |
|----------------------|--|----------------|---------|
| Each button | | | |
| CONTENTS | | | REMARKS |
| Element A/S Function | | | |
| Forced Defrosting | "FRZ. TEMP" + "REF. TEMP" 5 times | | |
| Pull Down | "REF. TEMP"+ "Freezer Door Switch" OPEN/CLOSE 5 times | | |
| Demo function | "FRZ. TEMP"+ "Refrigerator Door Switch" OPEN/CLOSE 5 times | | |
| Error display | "REF. TEMP"+ "FRZ. TEMP" 5 times | | |

4-10-2. FRS(N)-20BE* Type

| INPUT | | CONTROL OBJECT | |
|----------------------|-------------------------------------|----------------|---------|
| Each button | | | |
| CONTENTS | | | REMARKS |
| Element A/S Function | | | |
| Forced Defrosting | "FRZ. SET" + "REF. SET" 5 times | | |
| Pull Down | "SUPER REF." + "SUPER FRZ." 5 times | | |
| Demo function | "REF. SET" + "SUPER REF." 5 times | | |
| Error display | "FRZ. SET"+ "SUPER FRZ." 5 times | | |

4-10-3. Dispenser Model

| INPUT | | CONTROL OBJECT | |
|---|---|----------------|---------|
| Each button | | | |
| CONTENTS | | | REMARKS |
| 1. All the modes are started "LOCK" mode (except "FILTER RESET" mode) | | | |
| 2. Element A/S Function | | | |
| Forced Defrosting | "FREEZER SET" + "REFRIGERATOR SET" 5 times | | |
| Reset water filter | Push "RESET WATER FILTER" for 3 seconds | | |
| Demo function | "REFRIGERATOR SET" + "WATER/ICE" 5 times | | |
| Pull Down | "REFRIGERATOR SET"+ "FREEZER SET"+ "WATER/ICE"5 times | | |
| Error display | "FREEZER SET"+ "SUPER FREEZER" 5 times | | |
| EEPROM clear | "WATER/ICE"+ "RESET WATER FILTER" 5 times | | |
| Ice maker test | "WATER/ICE" + "ICE MAKER LOCK" 5 times | | |

**4-11. Filter information & Function to adjust the amount of water
(Dispenser Model Only)**

| INPUT | CONTROL OBJECT | |
|--|-----------------|---------|
| Temperature Control Buttons | 88 Display CLED | |
| CONTENTS | | |
| <div data-bbox="113 506 376 562" style="border: 1px solid black; padding: 2px; margin-bottom: 10px;">Filter information</div> <p>1. Filter Exchange Information : Record a real-time from the point of power input.</p> <ul style="list-style-type: none"> - The filter is normal for 6 months after the first installation. - When the time comes to change or reset, press the "Water Filter Reset" button for 3 seconds. <p>2. Function of display of filter change time</p> <p>[step1] Press the "Lock" button (not "Ice maker lock" button).</p> <p>[step2] Press "Super Freezer" button 5 times while pressing "Freezer Set" button.</p> <p>[step3] Press "Freezer Set" button 6 times successively. ("Fi – Lt" is display)</p> <p>[step4] Remaining time is display if "Dispenser" button press. (ex. 40 : 12 means that 4012 minutes remains until the filter exchange.)</p> <p>[step5] Reset : Push "Lock" button or it is automatically reset after 4 minutes.</p> | | REMARKS |
| <div data-bbox="113 1070 528 1126" style="border: 1px solid black; padding: 2px; margin-bottom: 10px;">Adjust the amount of water</div> <p>Function to adjust the amount of water supply.</p> <p>[step1] Press the "Lock" button (not "Ice maker lock" button).</p> <p>[step2] Press "Super Freezer" button 5 times while pressing "Freezer Set" button.</p> <p>[step3] Press "Freezer Set" button 5 times successively. ("P100" is display) (Initial setting "P100" means "86cc" water supply.)</p> <p>[step4] Adjust the amount of water.</p> <ul style="list-style-type: none"> - If the amount is less than P100, press "Super Cool" button. ; P101 (87cc) , P102 (88cc), P103 (89cc) - If the amount is more than P100, press "Refrigerator Set" button. ; P99 (85cc), P98 (84cc), P97 (83cc) <p>[step5] Reset : Push "Lock" button or it is automatically reset after 4 minutes.</p> | | |

4-12. Automatic Icemaker (Dispenser Model Only)

| INPUT | CONTROL OBJECT | |
|--|----------------------|---------|
| Full ice sensing switch Ice Maker Lock Sensors | Ice separating motor | |
| CONTENTS | | REMARKS |
| <p>1. Flow of ice making</p> <pre> graph TD START([START]) --> IM[Ice making mode] IM --> WSB["(water supply stand by)"] WSB --> ISM[Ice separating mode] ISM --> WSM[Water supply mode] WSM --> WSCM[Water supply check mode] WSCM --> RETURN([RETURN]) </pre> <p>1) Press TEST switch under the Icemaker for more than 1 second and test starts. * Test mode starts from ice separating mode. * In case test switch has an error of short, test is done only once.</p> | | |

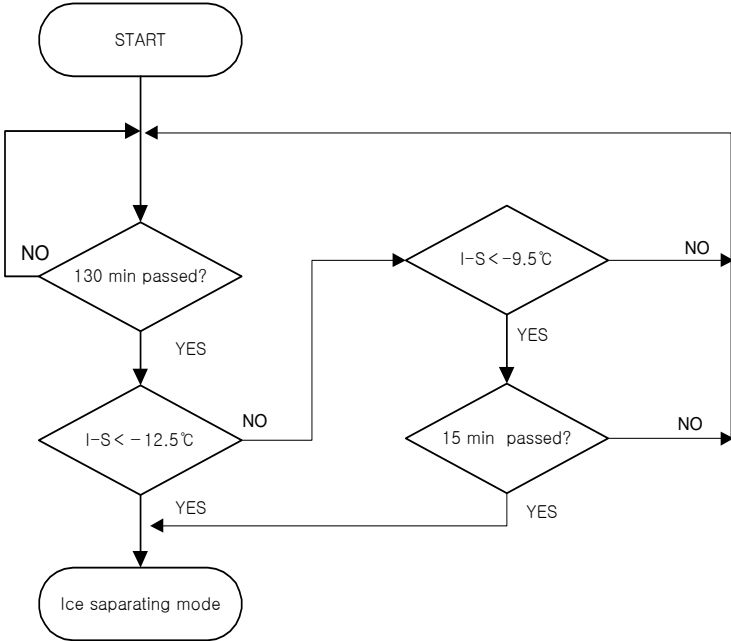
| CONTENTS | REMARKS |
|--|---------|
| <p>2) With the initial power input, Ice tray turns to be horizontal and ice making mode starts.</p> <p>3) Control of water hose heater</p> <ul style="list-style-type: none"> * Heater is always ON if RT-sensor has an error or RT is below 15 degree. * Heater is always ON for 60 minutes (max. Limit time) if Flow-sensor has an error <p>4) Water supply stand-by</p> <p>Condition : if ice is sensed full</p> <p>Operation : proceeds to Ice making mode (Ice separating and water supply Modes stop)</p> <p>5) Crusher Function</p> <p>It stops operation when freezer door is open</p> <p>It operates if freezer door is closed.</p> | |
| <p>2 Ice making mode</p>  <pre> graph TD Start([START]) --> D1{130 min passed?} D1 -- NO --> Start D1 -- YES --> D2{I-S < -12.5°C} D2 -- NO --> D3{I-S < -9.5°C} D2 -- YES --> End([Ice separating mode]) D3 -- NO --> Start D3 -- YES --> D4{15 min passed?} D4 -- NO --> D3 D4 -- YES --> End </pre> <p>1) Ice making stops if ice-sensor is below -12.5°C after 130 minutes.</p> <p>2) Ice making also stops if ice-sensor is below -9.5°C for 15 minutes, though ice-sensor is not below -12.5°C after 130 minutes.</p> <p>3) In case of ice sensor, ice making stops after 4.8 hours.</p> | |

| CONTENTS | REMARKS |
|----------|---------|
|----------|---------|

3. Ice separating (drop) mode

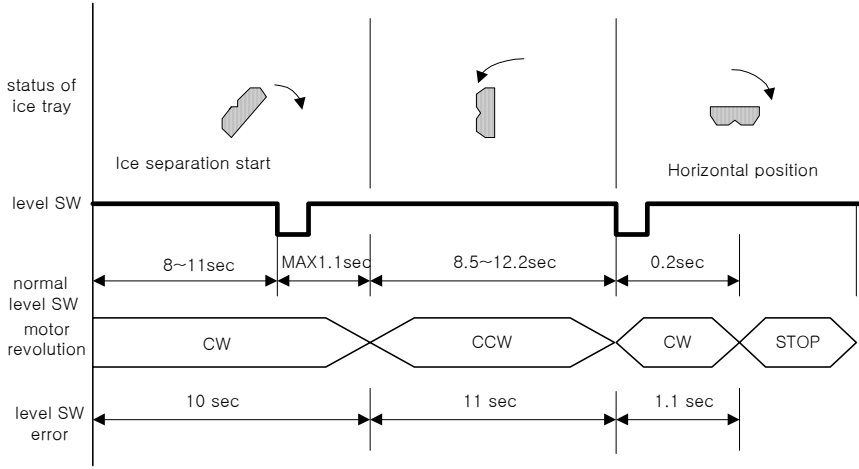

- 1) Time of each zone used to verify level switch error
- 2) The rotation of motor is sensed at each zone
- 3) In case of level switch error, ice separation is done by time.
- 4) If ice separating motor has error, the mode stop.

4. Water supply mode

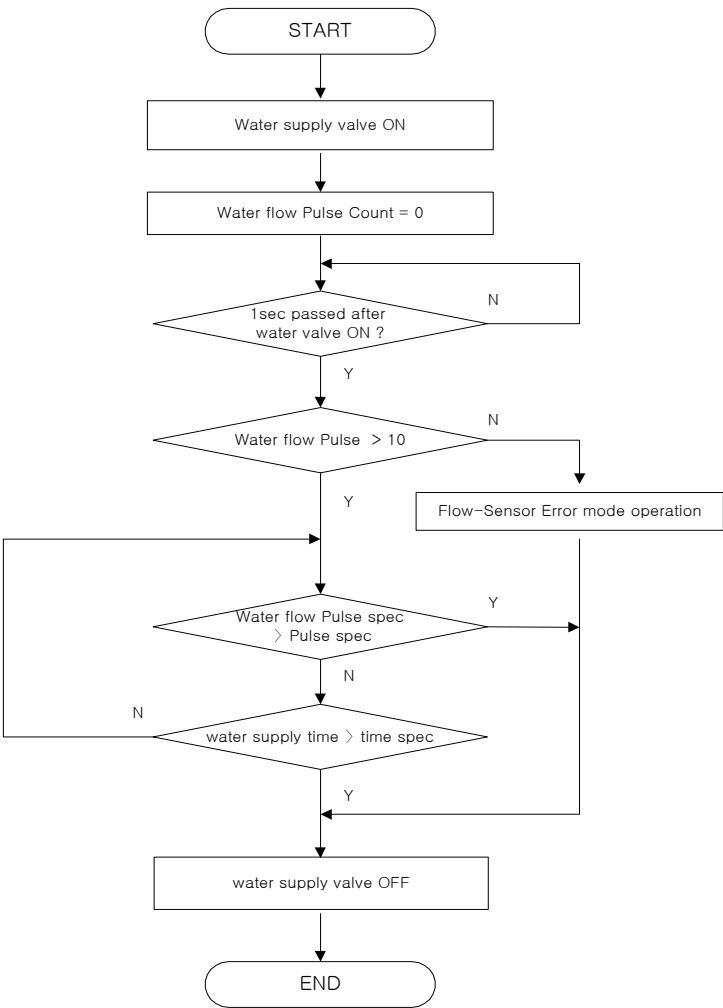

| CONTENTS | REMARKS | | | | | | | | | | | | | | |
|--|---------|------|------|------|------|-------|-------|-----|------|-----|-----|-----|-----|-----|--|
| <p>1) Water supply valve is open when water supply mode starts after separation of ices.</p> <p>2) Water is supplied by time in case sensor has error.</p> <p>3) Factor valve is variable which can be useful in AS action</p> <p>① Water flow pulse is set to 238 if flow sensor is in normal condition. (If water is supplied by time, maximum water supply time 165 seconds)</p> <p>② In case water flow sensor has error, water time is 5.5 seconds.</p> <p>5. Water supply check mode 5 minutes after water supply the status can be checked by RT-sensor and increase of temp. Ice sensor.</p> <table border="1" style="width: 100%; text-align: center;"> <tr> <td>RT-S</td> <td>9℃ ↓</td> <td>~15℃</td> <td>~21℃</td> <td>~31℃</td> <td>~41℃</td> <td>41℃ ↑</td> </tr> <tr> <td>I-S</td> <td>-10℃</td> <td>-9℃</td> <td>-8℃</td> <td>-7℃</td> <td>-6℃</td> <td>-5℃</td> </tr> </table> | RT-S | 9℃ ↓ | ~15℃ | ~21℃ | ~31℃ | ~41℃ | 41℃ ↑ | I-S | -10℃ | -9℃ | -8℃ | -7℃ | -6℃ | -5℃ | |
| RT-S | 9℃ ↓ | ~15℃ | ~21℃ | ~31℃ | ~41℃ | 41℃ ↑ | | | | | | | | | |
| I-S | -10℃ | -9℃ | -8℃ | -7℃ | -6℃ | -5℃ | | | | | | | | | |

4-13. Dispenser Control Function

| INPUT | CONTROL OBJECT |
|---|---|
| Dispenser switch WATER/ICE Button ICE MAKER LOCK Button Freezer Door Switch | Dispenser Lamp Crusher Motor Flap Solenoid Crusher Solenoid Dispenser Water Valve |
| CONTENTS | REMARKS |
| <p>1) Initial mode : water (Mode change : Water → Cubed ice → Crushed ice) - Selected icon LED turns ON and others are OFF.</p> <p>2) ICE MAKER LOCK Button Icemaker Lock function and its ICON Turn ON/OFF by pressing the button.</p> <p>3) Display</p> <p>① Water ICON turns ON as default mode</p> <p>② The ICON of each mode turns ON by pressing its button. (If display switch makes error during operation of a mode, its ICON turns OFF)</p> <p>③ When Icemaker Lock ICON turns ON.</p> <p>- ICE MAKER LOCK ICON turns ON</p> <p>- If it is in the mode of Cubed Ice or Crushed Ice, the mode is changed to Water and Water ICON turns ON</p> <p>- If there is no button input for 1 hour after selecting Cubed Ice or Crushed Ice the mode turns to Water (default)</p> | |

| CONTENTS | REMARKS |
|----------|---------|
|----------|---------|

4) Control Flow & Timing Chart
 ① Crushed Ice

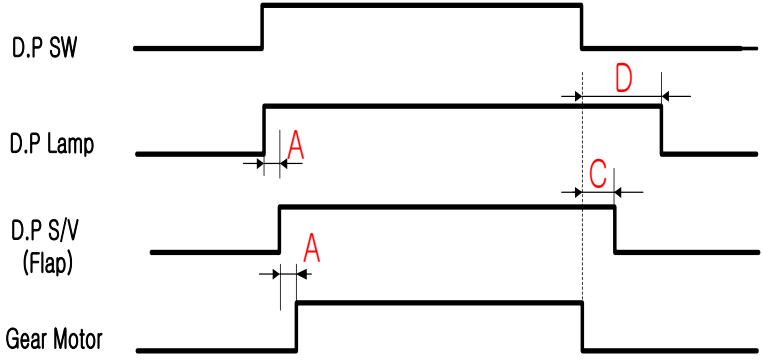

② Cubed Ice

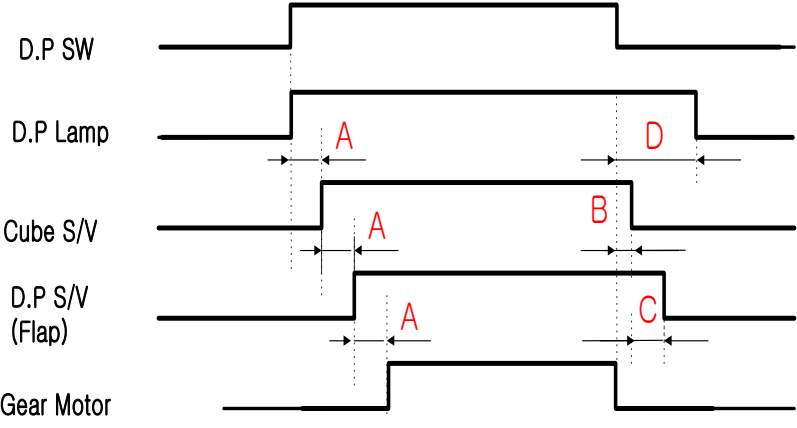

③ Water

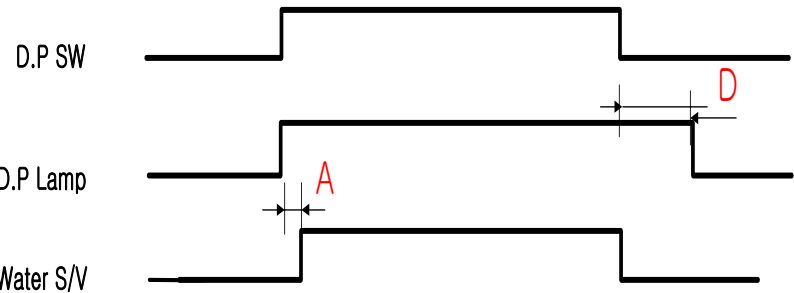

Delay time : A = 500ms, B = 500ms, C = 2.0s, D = 5.0s

5. WIRING DIAGRAM

5-1. FRS-U20IE* (R-134a)

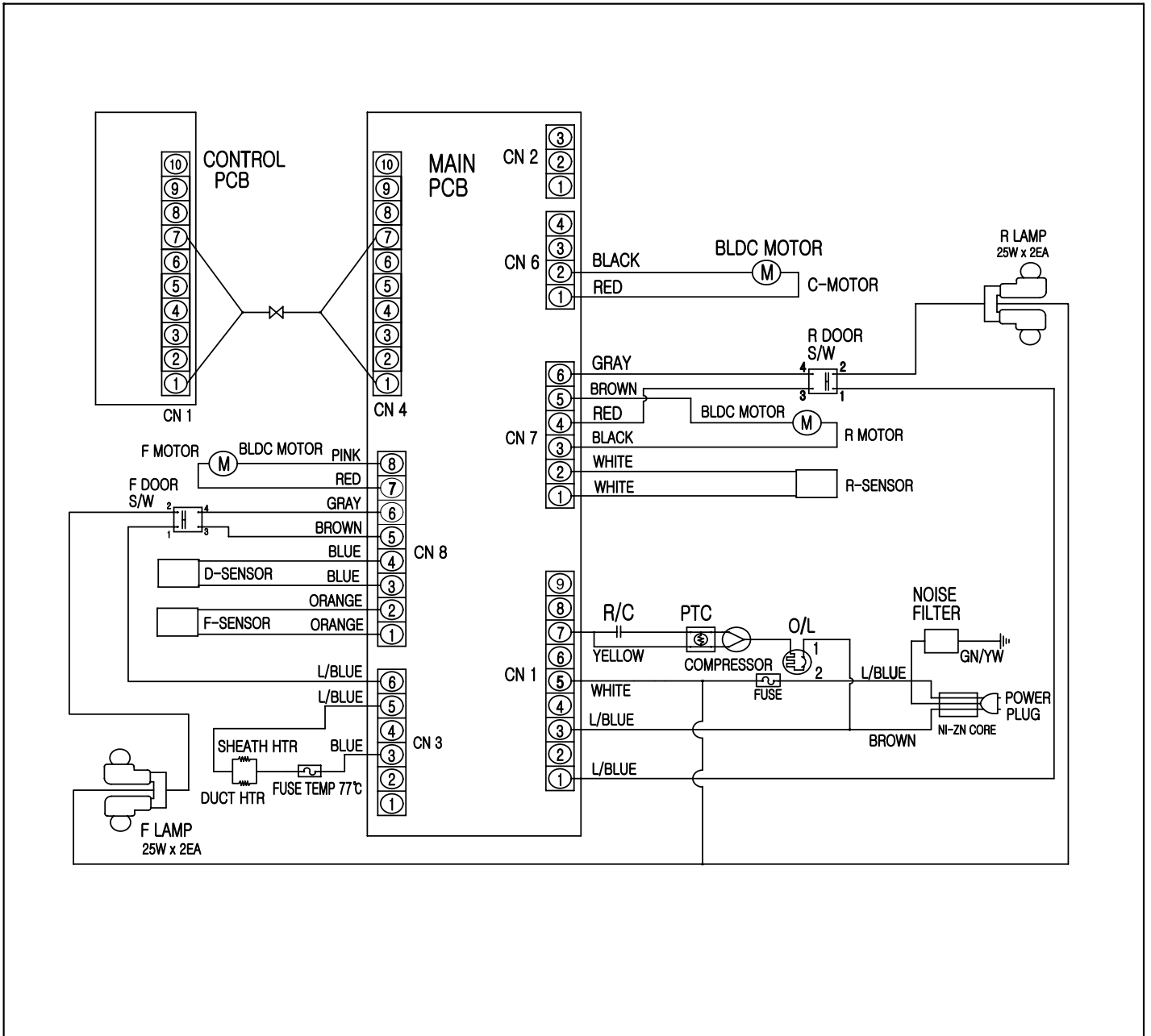

5-2. FRN-U20IE* (R-600a)

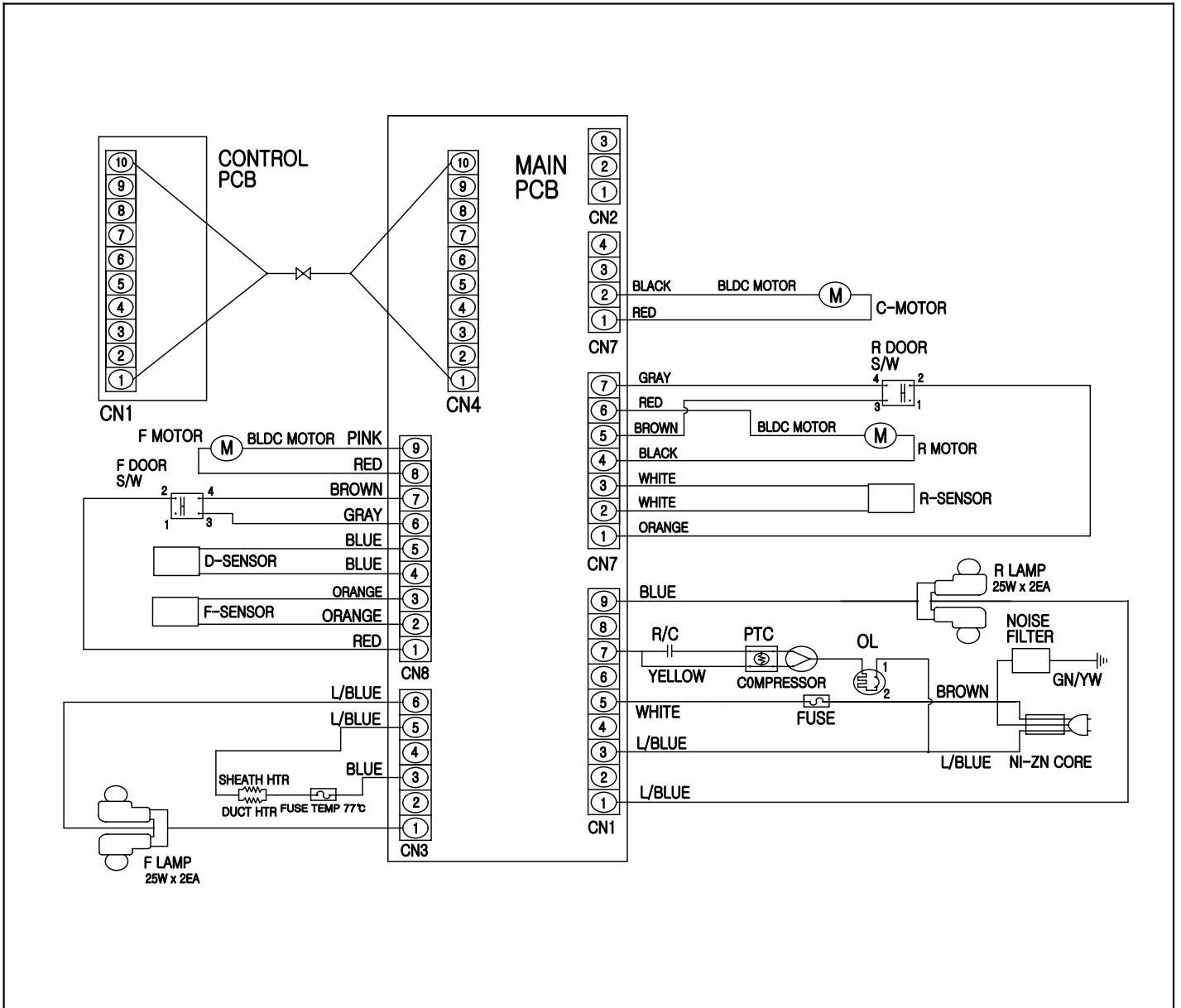

5-3. FRS-U20BE* (R-134a)

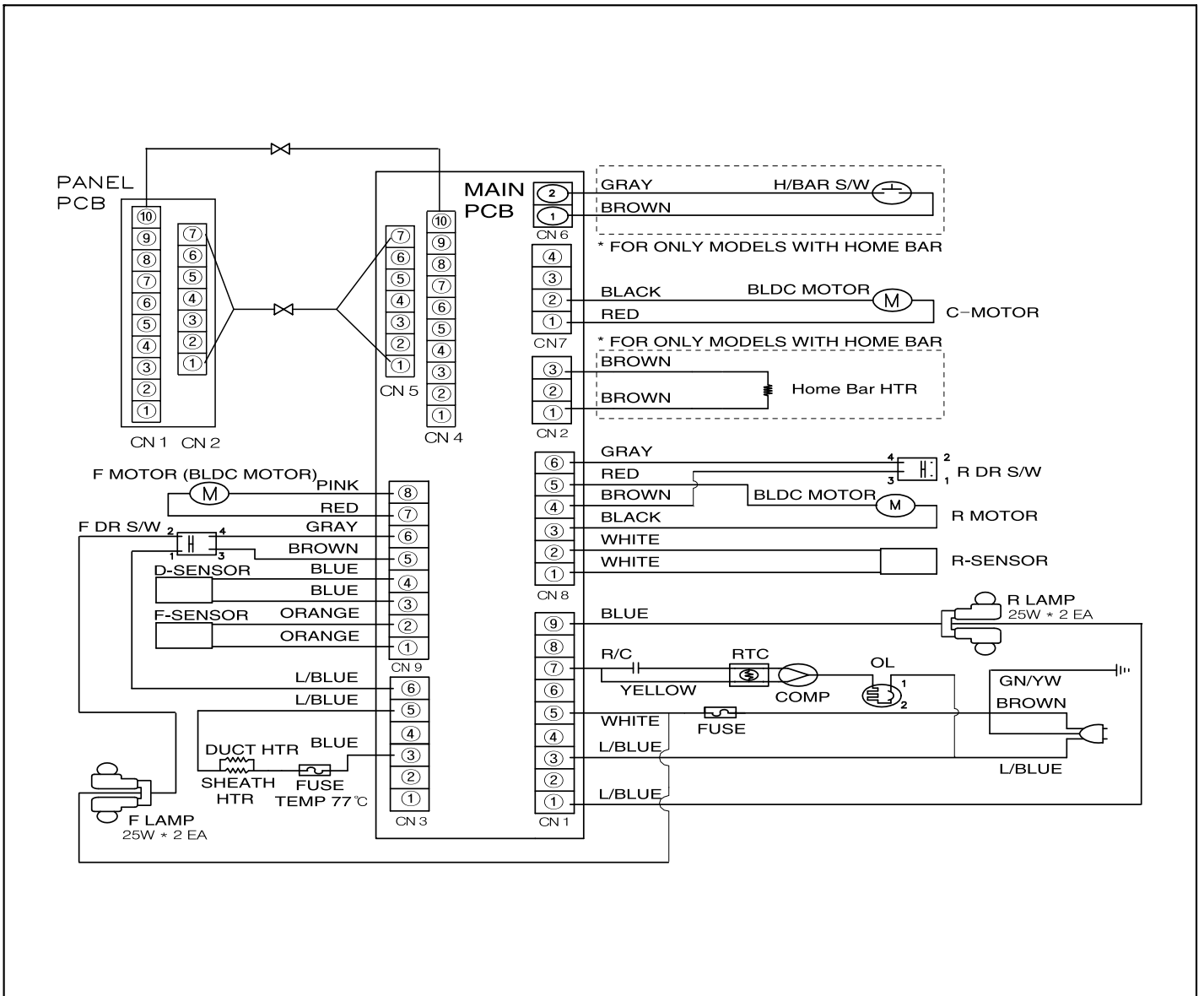

5-4. FRN-U20BE* (R-600a)

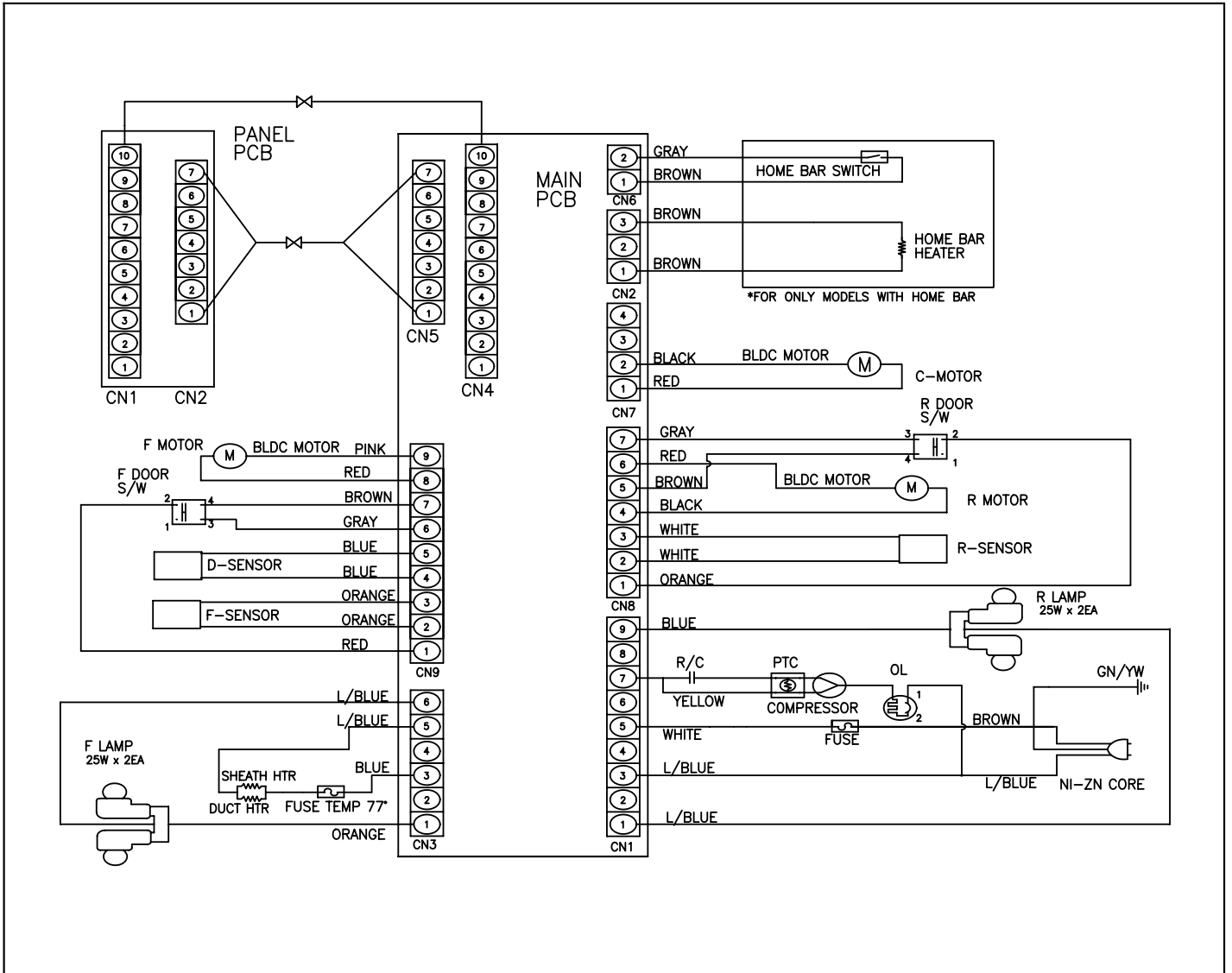

5-5. Dispenser Models (R-600a or R-134a)

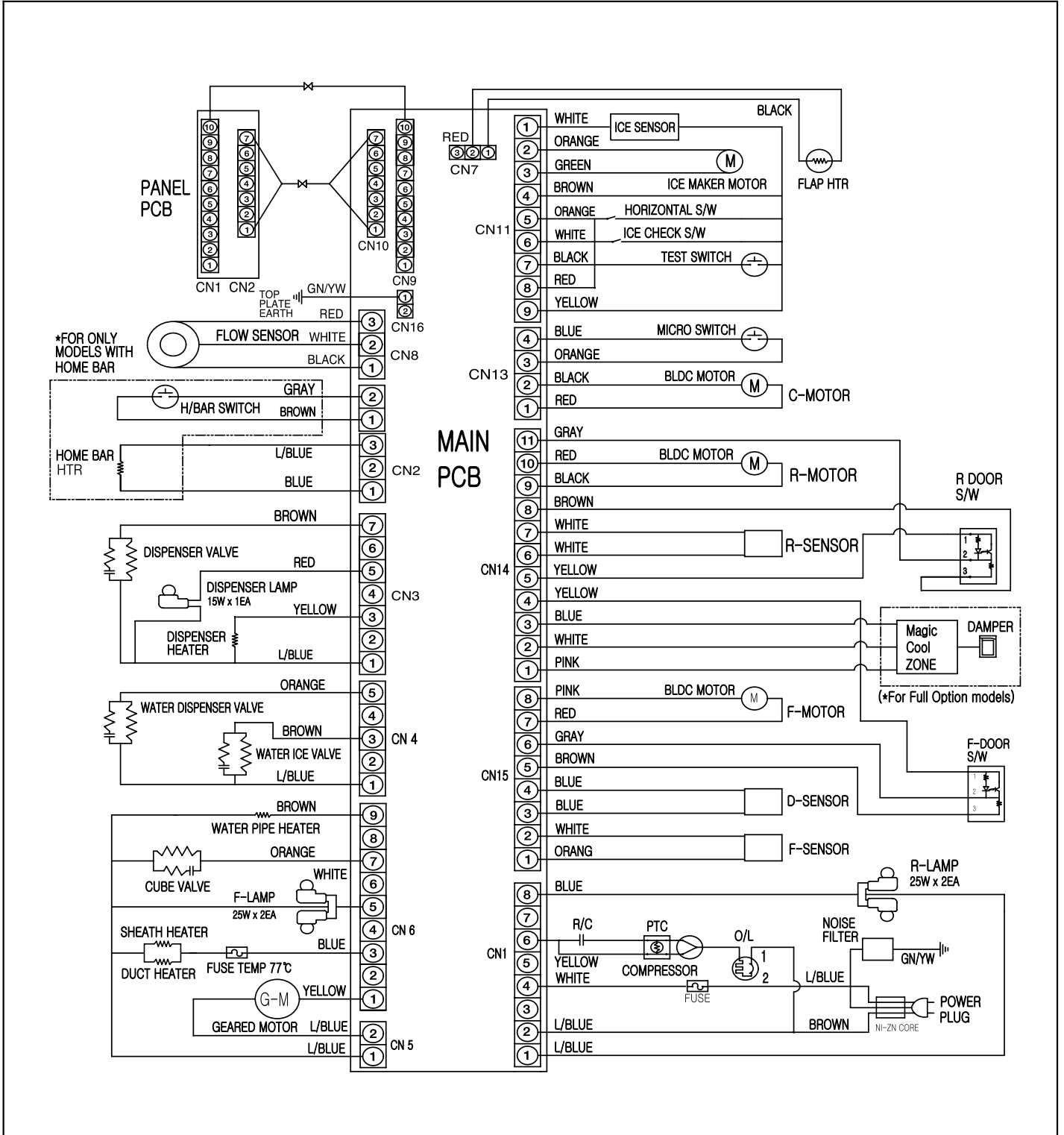

6. COMPONENT LOCATE VIEW

6-1. Front View (Dispenser + Home bar Model)

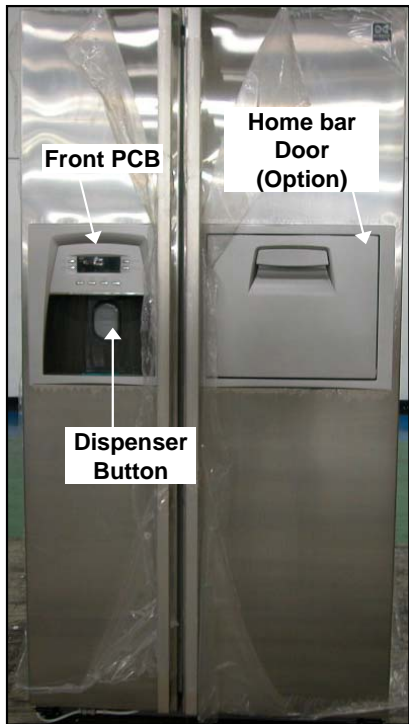

6-2. Inner View

Automatic Ice Maker F-Fan Motor Geared Motor

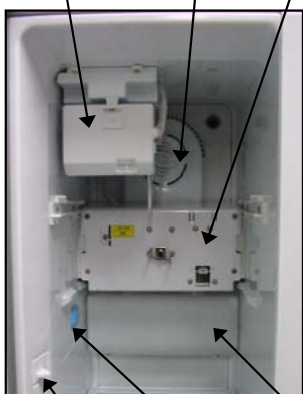

F-Door Switch F-Sensor F-Lamp

Freezer Compartment (Dispenser Model)

R-Fan Motor R-Sensor R-Lamp

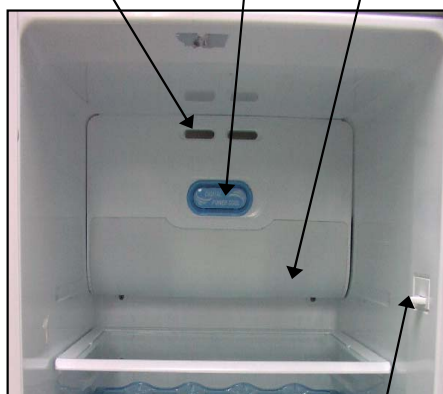

R-Door Switch

Refrigerator Compartment (Dispenser Model)

R-Sensor Inner Controller

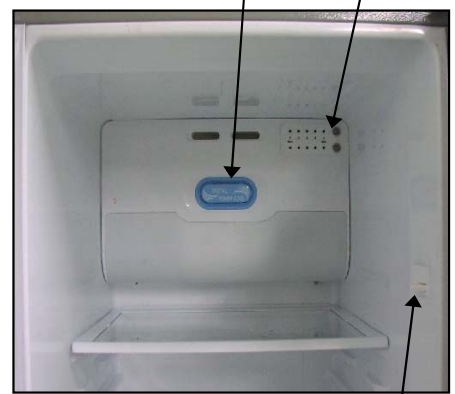

R-Door Switch

Refrigerator Compartment (Inner Basic Model)

6-3. Evaporator

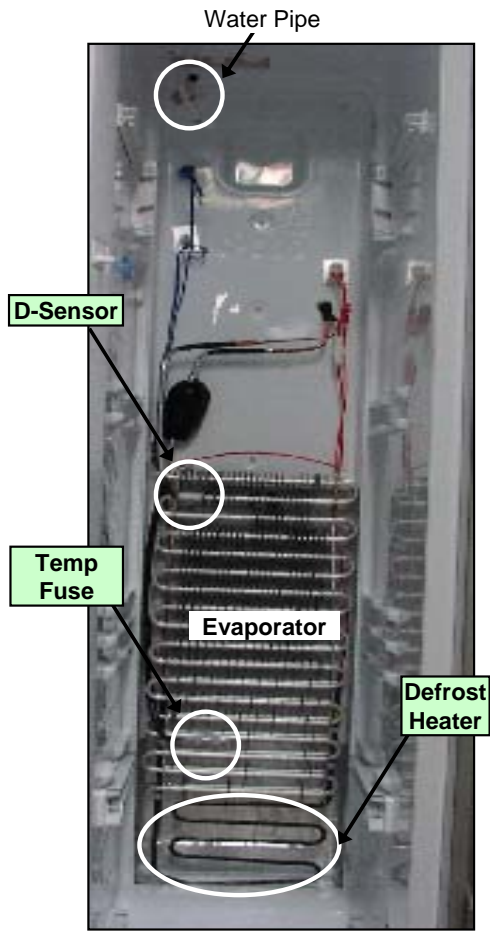



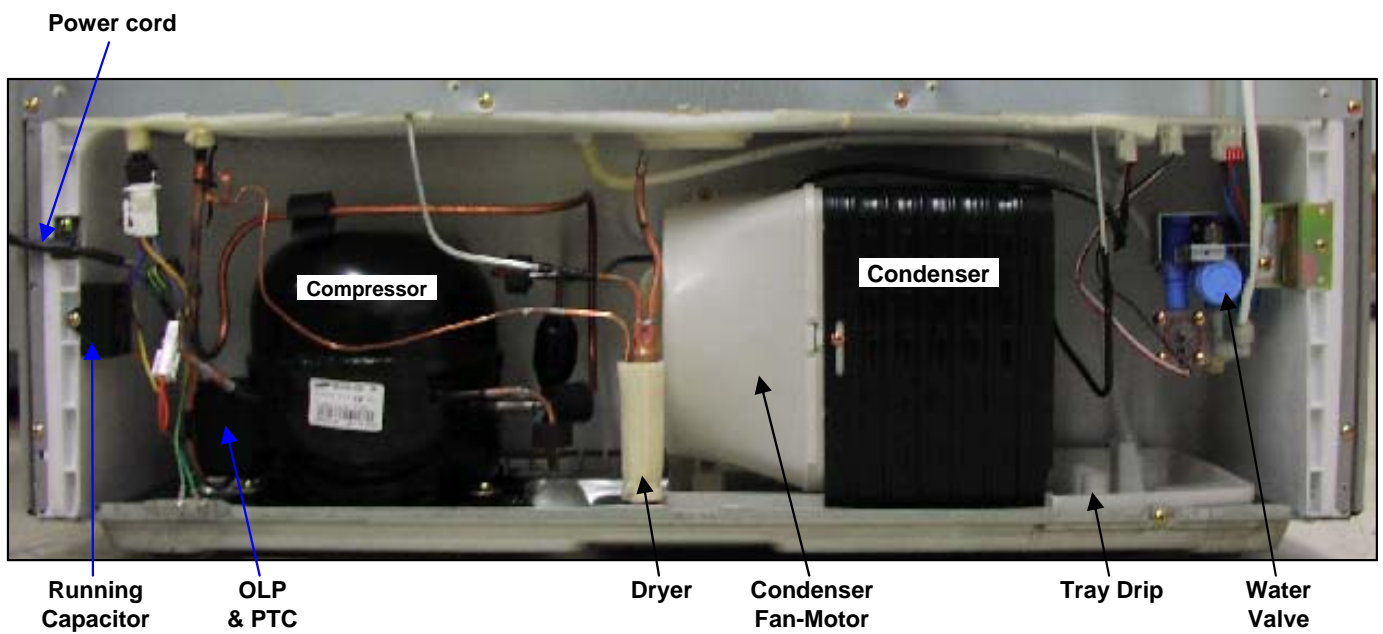





6-4. Machine Compartment



7. HOW TO CHECK EACH PARTS

7-1. Hose Ice Maker Tube Assembly

1) Disassembling Procedure





| NO | DISASSEMBLING PROCEDURE | NO | DISASSEMBLING PROCEDURE |
|----|---|----|---|
| 1 |  ▷ Pull forward Ice Storage Case | 5 |  ▷ Remove 2 screws at the Cove Guide Cab W/Tube A. |
| 2 |  ▷ Remove 2 screws. | 6 |  ▷ Disassemble Cover Guide Cab W/Tube A |
| 3 |  ▷ Pull forward Ice Maker. | 7 |  ▷ Pull forward Hose Ice Maker Tube As. |
| 4 |  ▷ Remove Water Hose Heater's 2P housing. | 8 |  ▷ Check Hose Ice Maker Tube As. |

2) How to check Hose Ice Maker Tube As.

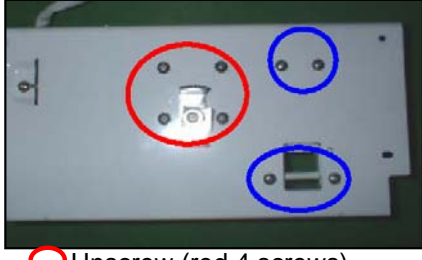

| How to check | CRITERION |
|--|---|
|  ▷ Measure the resistance of two wire | ▷ Good: $9680\Omega(\pm 8\%)$ (8900 ~ 10456 Ω) ▷ If defective, change |

7-2. Bracket Geared Motor Assembly

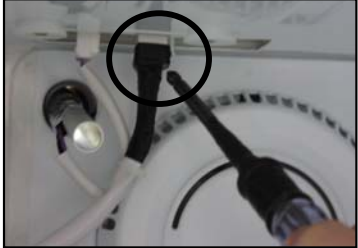
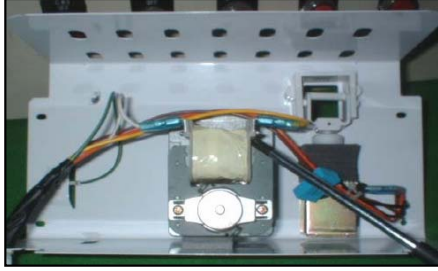
1) Disassembling Procedure



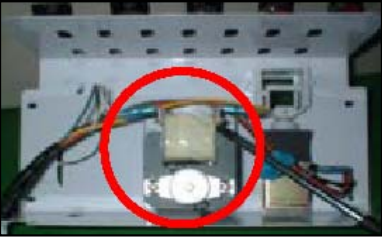

| NO | DISASSEMBLING PROCEDURE | NO | DISASSEMBLING PROCEDURE |
|----|--|----|---|
| 1 |  <p>▷ Remove 2 screws.</p> | 4 |  <p>▷ Pull forward Bracket Geared Motor.</p> |
| 2 |  <p>▷ Unscrew (4 points).</p> | 5 |  <p>  Unscrew (red 4 screws).  Unscrew (blue 4 screws). </p> |
| 3 |  <p>▷ Separate 6 pin housing of Bracket Geared Motor from the top connector.</p> | 6 |  <p>▷ Check Solenoid Valve and Geared Motor.</p> |

2) How to Check Hose Ice Maker Tube Assembly

| PARTS | SPEC. | HOW TO CHECK | CRITERION |
|----------------|--|--|--|
| Geared Motor | <p>▷ SPEC. NAME :DAG-6502DEC</p> <p>▷ VOLTAGE :220/240V,50Hz</p> |  <p>▷ Check resistance value of 2 terminals with a Multi Tester.</p> | <p>▷ GOOD : $11.3\Omega(\pm 10\%)$ (10.8 ~ 12.7Ω)</p> <p>▷ DEFECTIVE ; Change the Geared Motor.</p> |
| Cube Sol Valve | <p>▷ SPEC. NAME :Cube SN8</p> <p>▷ VOLTAGE :220/240V,50Hz</p> |  <p>▷ Check resistance value of 2 terminals with a Multi Tester.</p> | <p>▷ GOOD : $145\Omega(\pm 8\%)$ (133 ~ 156Ω)</p> <p>▷ DEFECTIVE ; Change the Cube Sol Valve.</p> |

7-3. Dispenser Micro Switch

1) Disassembling Procedure



| NO | DISASSEMBLING PROCEDURE | NO | DISASSEMBLING PROCEDURE |
|----|---|----|---|
| 1 |  <p>▷ Insert (-) screw driver into bottom hole of Dispenser Button Guide. Pull up forward to remove the guide. (Be careful not to damage guide surface.)</p> | 3 |  <p>▷ Separate wire connectors from Micro Switch.</p> |
| 2 |  <p>▷ Remove Micro switch.</p> | 4 |  <p>▷ Check Micro Switch.</p> |

2) How to Check Micro Switch

| PARTS | HOW TO CHECK | CRITERION | | | | | | | | | |
|---|--|---|---------------------------|------------------------|---------------------------------|------------|-----------|------------|------------|--------------|--------------|
| <p>SPEC. NAME : VP333A-OD-8</p> <p>VOLTAGE : 125V, 3A</p> |  <p>▷ Check both terminals (red circle) with a Multi Tester (Tester Mode : Resistance (Ω)).</p> | <p>▷ GOOD :</p> <table border="1"> <thead> <tr> <th>Tact Switch (Blue Circle)</th> <th>Terminals (Red circle)</th> <th>Tester Result (Resistance Mode)</th> </tr> </thead> <tbody> <tr> <td>ON (Close)</td> <td>Connected</td> <td>Some Value</td> </tr> <tr> <td>OFF (Open)</td> <td>Disconnected</td> <td>No value (0)</td> </tr> </tbody> </table> <p>▷ DEFECTIVE : Change Micro Switch.</p> | Tact Switch (Blue Circle) | Terminals (Red circle) | Tester Result (Resistance Mode) | ON (Close) | Connected | Some Value | OFF (Open) | Disconnected | No value (0) |
| Tact Switch (Blue Circle) | Terminals (Red circle) | Tester Result (Resistance Mode) | | | | | | | | | |
| ON (Close) | Connected | Some Value | | | | | | | | | |
| OFF (Open) | Disconnected | No value (0) | | | | | | | | | |

7-4. Dispenser Solenoid Valve

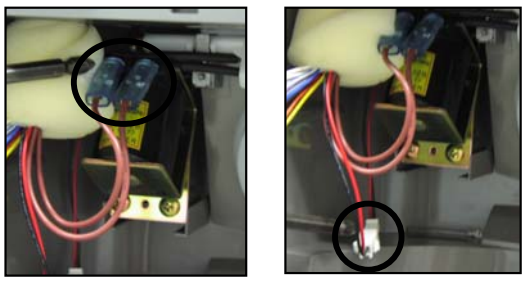
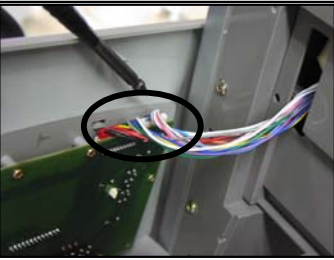
1) Disassembling Procedure

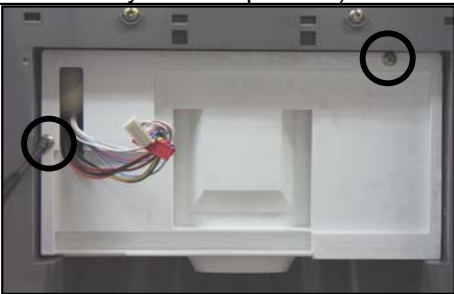
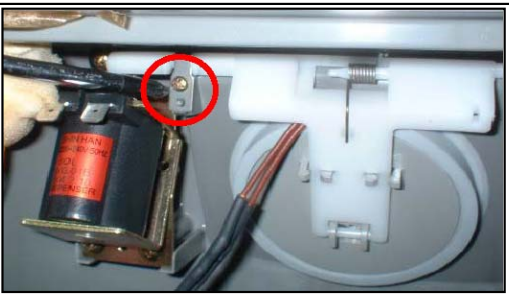
| NO | DISASSEMBLING PROCEDURE | NO | DISASSEMBLING PROCEDURE |
|----|--|----|--|
| 1 |  <p>▷ Insert (-) screw driver into bottom left groove of Cover Dispenser Box. Pull forward with a snap.(Be careful not to damage cover and door surface.)</p> | 4 |  <p>▷ Separate 2 terminals from Sol Valve and 2P Housings from Cover Ice Flap.</p> |
| 2 |  <p>▷ Separate 2 housings of 10P / 7P from Front PCB. (Do not hold only wires to pull out.)</p> | 5 |  <p>▷ Unscrew (3 points) to remove Sol Valve.</p> |
| 3 |  <p>▷ Unscrew (2 points) to remove Box Dispenser Shut.</p> | 6 |  <p>▷ Unscrew (1 point) to remove Cover Ice Flap.</p> |

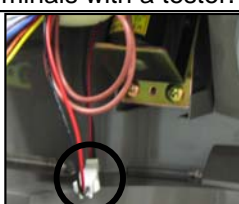

2) How to Check Micro Switch

| PARTS | SPEC. | HOW TO CHECK | CRITERION |
|----------------------|--|--|--|
| Dispenser Sol Valve | <p>▷ SPEC. NAME :SOL2003-01B</p> <p>▷ VOLTAGE :220/240V,50Hz</p> |  <p>▷ Check resistance value of both terminals with a tester.</p> | <p>▷ Good : 215Ω(±10%) (193 ~ 236Ω)</p> <p>▷ DEFECTIVE : 0 Change Sol Valve.</p> |
| Flap Heater Assembly | <p>▷ VOLTAGE :DC 12V,1.5W</p> |  <p>▷ Check resistance value of both terminals with a tester.</p> | <p>▷ GOOD : 96Ω(±8%) (88 ~ 104Ω)</p> <p>▷ DEFECTIVE ; Change Flap Heater AS.</p> |

7-5. Main PCB

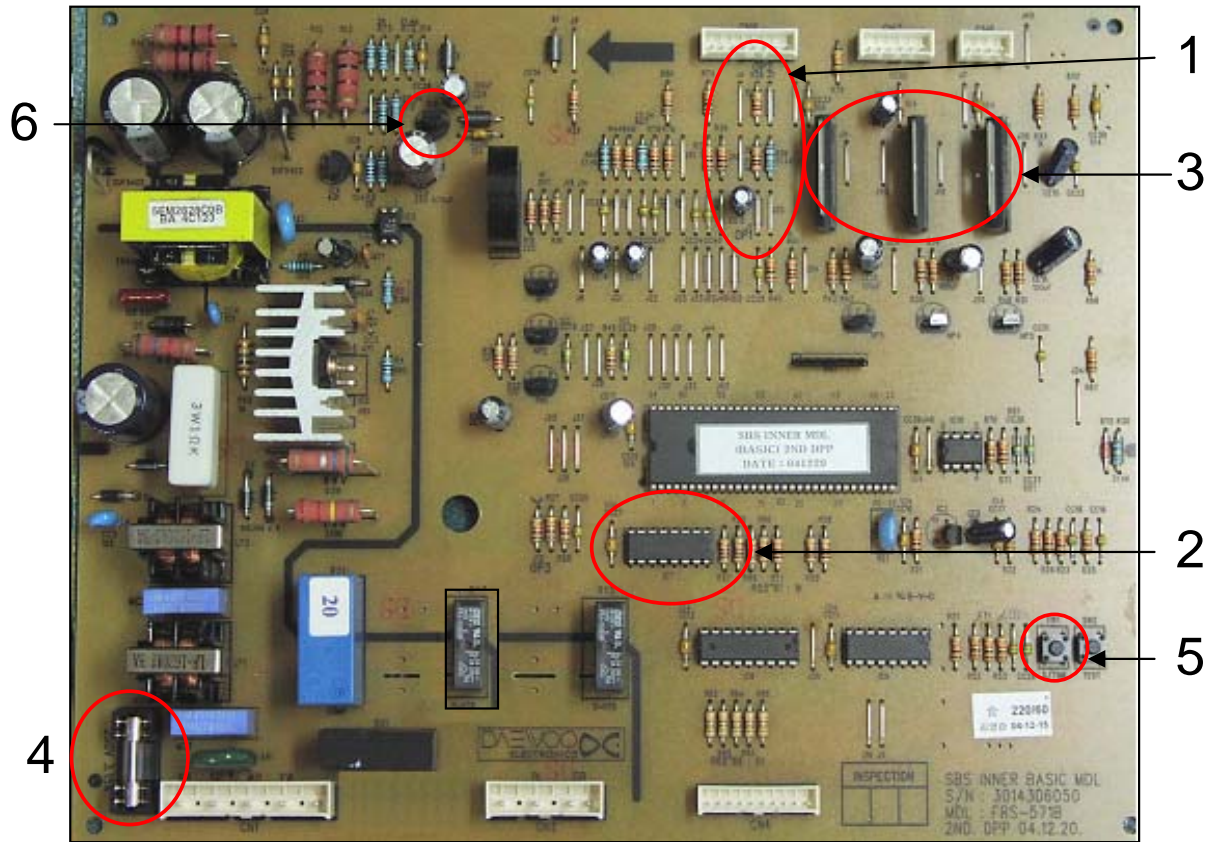

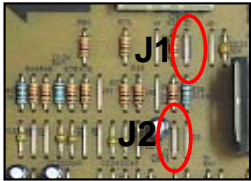
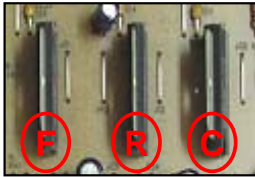
- Basic Model



| NO | ITEM | CHECK POINT | REMARK |
|----|--|---|--------|
| 1 | Compensation of Weak Refrigeration → Making R-temp cooler |  <p>* Used when making R-temp. down to compensate for weak refrigeration without changing FCP temp. setting. ▷ Cutting of J1 ; down by 1.5°C ▷ Cutting of J1, J2 ; down by 3°C</p> | |
| 2 | Relay Power Controller | <p>* To check normal voltage of each electrical devices to & from Mi-com. ▷ Check input & output voltage of MICOM and IC7</p> | |
| 3 | Fan Power Controller |   <p>* To check input & output voltage of Fan ▷ #2 : Input ▷ #5 : Output</p> | |
| 4 | Electric Current Fuse | <p>* To check when each device does not work (250V,3.15A)</p> | |
| 5 | Time Shortening Switch | <p>* To shorten time in PCB checkup (Pressing 1 time is regarded as 1 minute has passed.)</p> | |
| 6 | Regulator IC(5V) | <p>* To check voltage of MICOM and IC Voltage check of IC#6 (Input :12V,Output : 5V)</p> | |

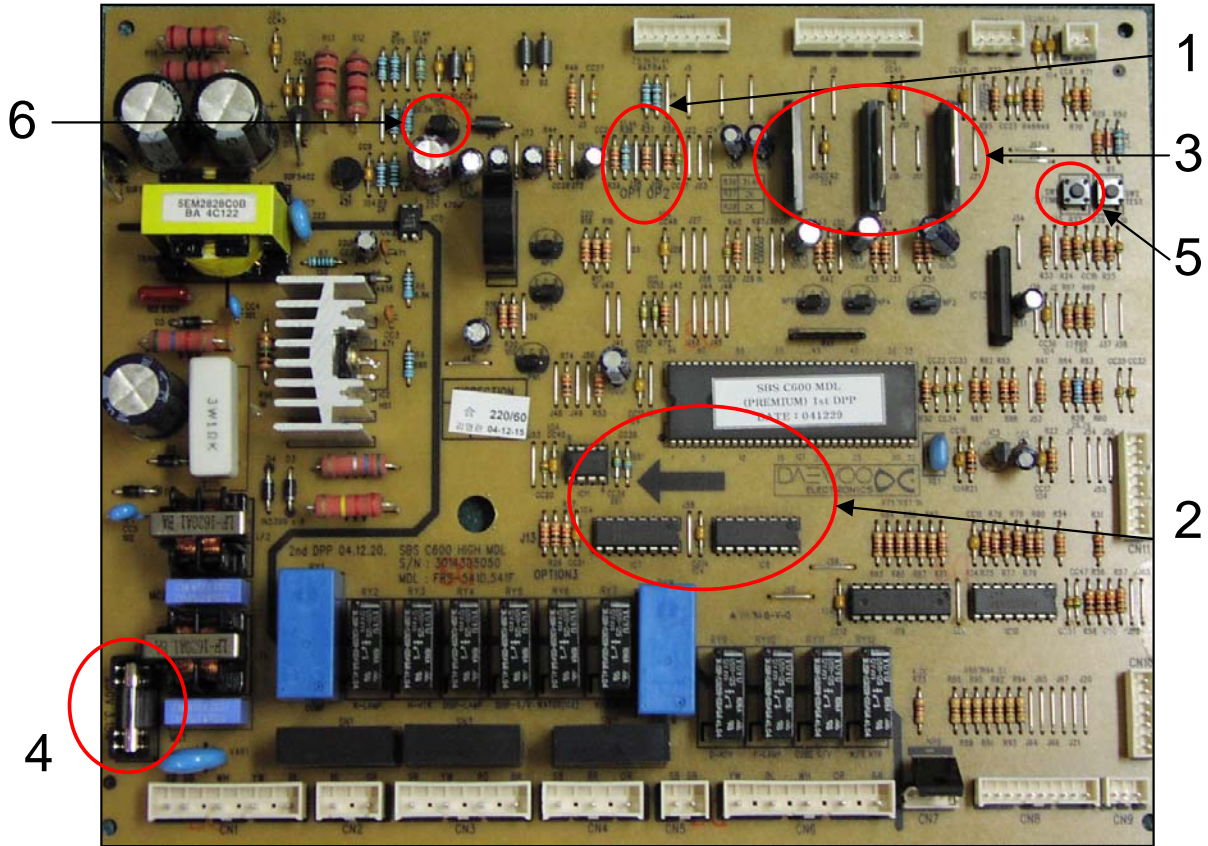

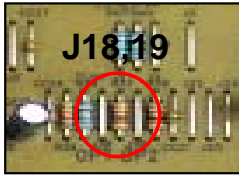
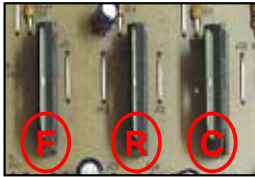

- Dispenser Model



| NO | ITEM | CHECK POINT | REMARK |
|----|---|--|--------|
| 1 | Compensation of Weak Refrigeration →Making R-temp cooler |  <p>* Used when making R-temp. down to compensate for weak refrigeration without changing FCP temp. setting. ▷ Cutting of J18 ; down by 1.5 °C ▷ Cutting of J18, J19 ; down by 3 °C</p> | |
| 2 | Relay Power Controller | <p>* To check normal voltage of each electrical devices to & from Mi-com. ▷ Check input & output voltage of MICOM and IC7, 8.</p> | |
| 3 | Fan Power Controller |   <p>* To check input & output voltage of Fan ▷ #2 : Input ▷ #5 : Output</p> | |
| 4 | Electric Current Fuse | <p>* To check when each device does not work (250V,3.15A)</p> | |
| 5 | Time Shortening Switch | <p>* To shorten time in PCB checkup (Pressing 1 time is regarded as 1 minute has passed.)</p> | |
| 6 | Regurator IC(5V) | <p>* To check voltage of MICOM and IC Voltage check of IC#6 (Input :12V,Output : 5V)</p> | |

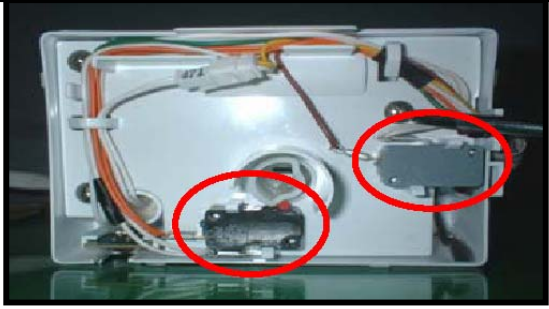

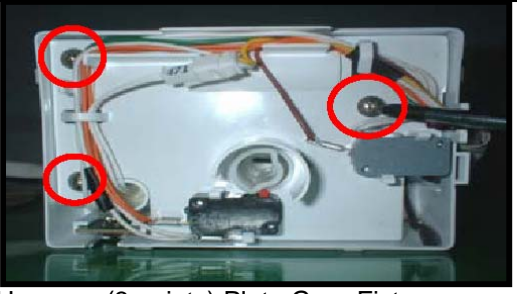
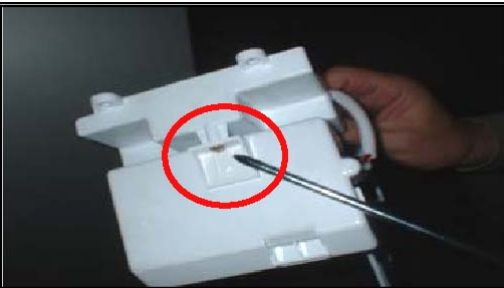
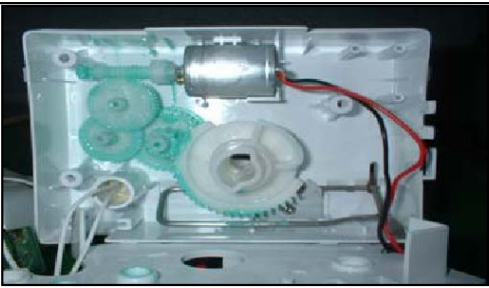
7-6. Ice Maker

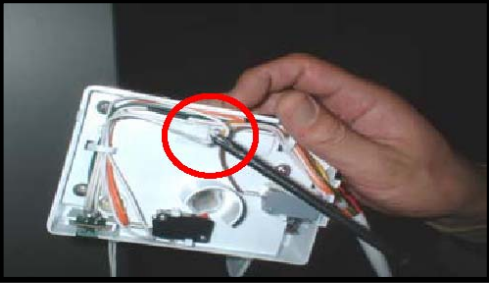
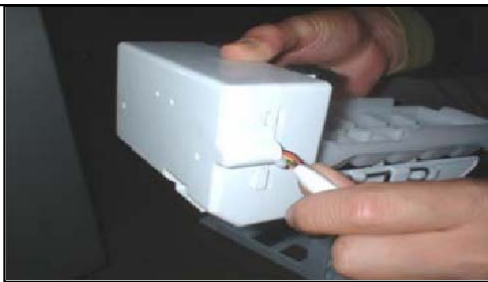
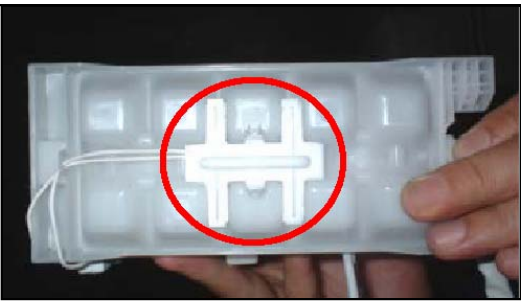
1) Disassembling Procedure

| NO | DISASSEMBLING PROCEDURE | NO | DISASSEMBLING PROCEDURE |
|----|---|----|---|
| 1 |  <p data-bbox="201 640 746 674">▷ Remove 2 screws on top front of ice maker.</p> | 6 |  <p data-bbox="882 640 1473 674">▷ Remove full ice sensing switch and level switch.</p> |
| 2 |  <p data-bbox="201 972 507 1005">▷ Pull forward ice maker.</p> | 7 |  <p data-bbox="882 972 1361 1005">▷ Unscrew (3 points) Plate Gear Fixture.</p> |
| 3 |  <p data-bbox="201 1323 659 1357">▷ Unscrew Fixture of Frame Ice Maker.</p> | 8 |  <p data-bbox="882 1323 1425 1357">▷ Check if ice dropping motor is normal (OK).</p> |
| 4 |  <p data-bbox="201 1637 639 1697">▷ Separate Ice Maker Assembly from Frame Ice Maker.</p> | 9 |  <p data-bbox="882 1653 1465 1686">▷ Remove 2 pin housing from Plate Gear Fixture.</p> |
| 5 |  <p data-bbox="201 2000 730 2060">▷ Separate Cover I/M (A) from Cover I/M (B) with a (-) screw driver.</p> | 10 |  <p data-bbox="882 2000 1329 2060">▷ Remove I-sensor (ice sensor) from Case Icing As.</p> |

* Follow the reverse order when assembling.

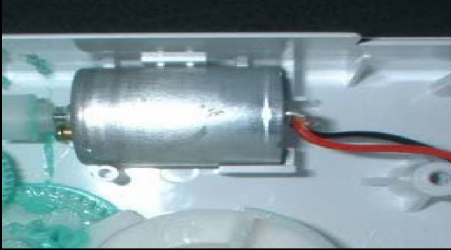
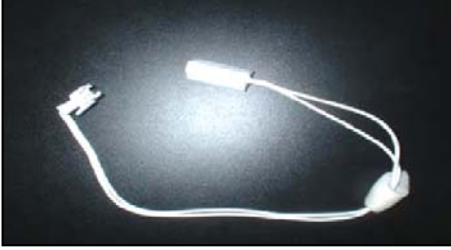
2) How to Check Ice Maker

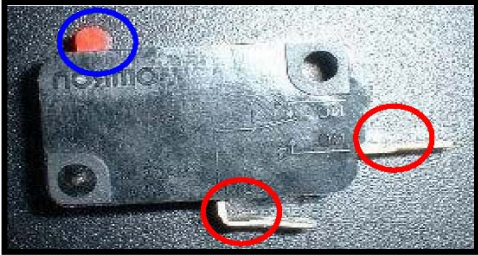
| PARTS | HOW TO CHECK | CRITERION | | | | | | | | | |
|---------------------------|---|--|---------------------------|------------------------|---------------------------------|------------|-----------|------------|------------|--------------|--------------|
| Ice Dropping Motor |  <p>▷ Check resistance value of 2 wires with a Multi Tester.</p> | <p>▷ GOOD : RS-360RH-14250 : 6 ~ 14Ω</p> <p>▷ DEFECTIVE : Change the motor.</p> | | | | | | | | | |
| I-Sensor (Ice Sensor) |  <p>▷ Check resistance value of 2 wires with a Multi Tester.</p> | <p>▷ GOOD : 4.4 ~ 50kΩ (It depends on surround temp.)</p> <p>▷ DEFECTIVE : Change the sensor.</p> | | | | | | | | | |
| Full Ice Sensing Switch |  <p>▷ Check resistance value of 2 terminals with a Multi Tester.</p> | <p>▷ GOOD :</p> <table border="1" data-bbox="906 1084 1513 1308"> <thead> <tr> <th>Tact Switch (Blue Circle)</th> <th>Terminals (Red circle)</th> <th>Tester Result (Resistance Mode)</th> </tr> </thead> <tbody> <tr> <td>ON (Close)</td> <td>Connected</td> <td>Some Value</td> </tr> <tr> <td>OFF (Open)</td> <td>Disconnected</td> <td>No value (0)</td> </tr> </tbody> </table> <p>▷ DEFECTIVE : Change the switch.</p> | Tact Switch (Blue Circle) | Terminals (Red circle) | Tester Result (Resistance Mode) | ON (Close) | Connected | Some Value | OFF (Open) | Disconnected | No value (0) |
| Tact Switch (Blue Circle) | Terminals (Red circle) | Tester Result (Resistance Mode) | | | | | | | | | |
| ON (Close) | Connected | Some Value | | | | | | | | | |
| OFF (Open) | Disconnected | No value (0) | | | | | | | | | |
| Level Switch |  <p>▷ Check resistance value of 2 terminals with a Multi Tester.</p> | <p>▷ GOOD :</p> <table border="1" data-bbox="906 1503 1513 1727"> <thead> <tr> <th>Tact Switch (Blue Circle)</th> <th>Terminals (Red circle)</th> <th>Tester Result (Resistance Mode)</th> </tr> </thead> <tbody> <tr> <td>ON (Close)</td> <td>Connected</td> <td>Some Value</td> </tr> <tr> <td>OFF (Open)</td> <td>Disconnected</td> <td>No value (0)</td> </tr> </tbody> </table> <p>▷ DEFECTIVE : Change the switch.</p> | Tact Switch (Blue Circle) | Terminals (Red circle) | Tester Result (Resistance Mode) | ON (Close) | Connected | Some Value | OFF (Open) | Disconnected | No value (0) |
| Tact Switch (Blue Circle) | Terminals (Red circle) | Tester Result (Resistance Mode) | | | | | | | | | |
| ON (Close) | Connected | Some Value | | | | | | | | | |
| OFF (Open) | Disconnected | No value (0) | | | | | | | | | |

8. TROUBLE DIAGNOSIS

8-1. Faulty Start (F/R lights OFF , F-PCB Power OFF)

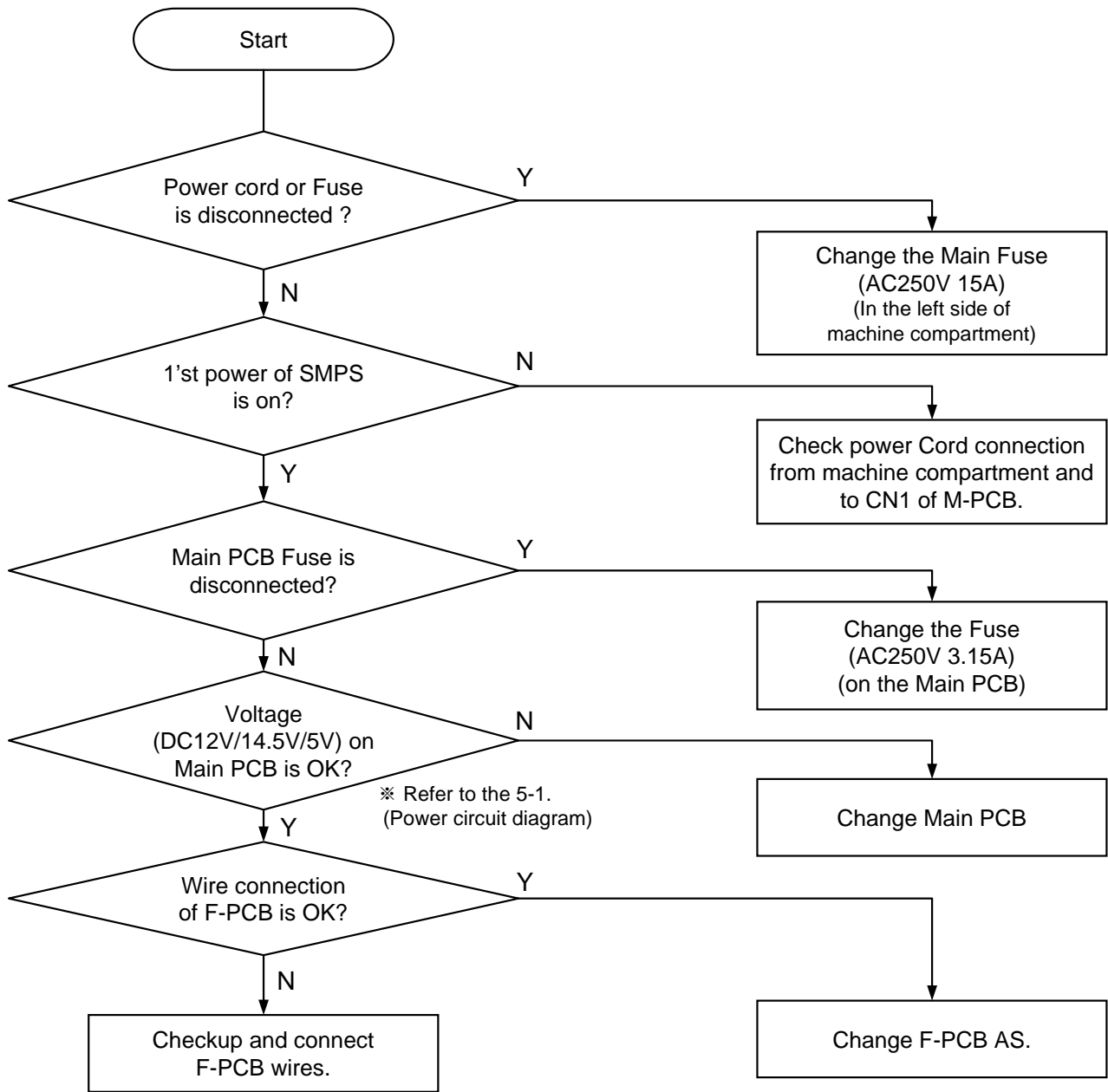

※ How to replace Front PCB



- 1) Insert a flat tip driver into the left down groove of panel frame and snap it out smoothly.
- 2) Separate 2 housings of 10P / 7P from Front PCB. (Do not hold only wires to pull out.)
- 3) Unscrew (7 points) to remove Front PCB.

* Follow the reverse order when assembling.

8-2. Freezer Compartment

8-2-1. Freezing failure . (Foods are not frozen / cold.)

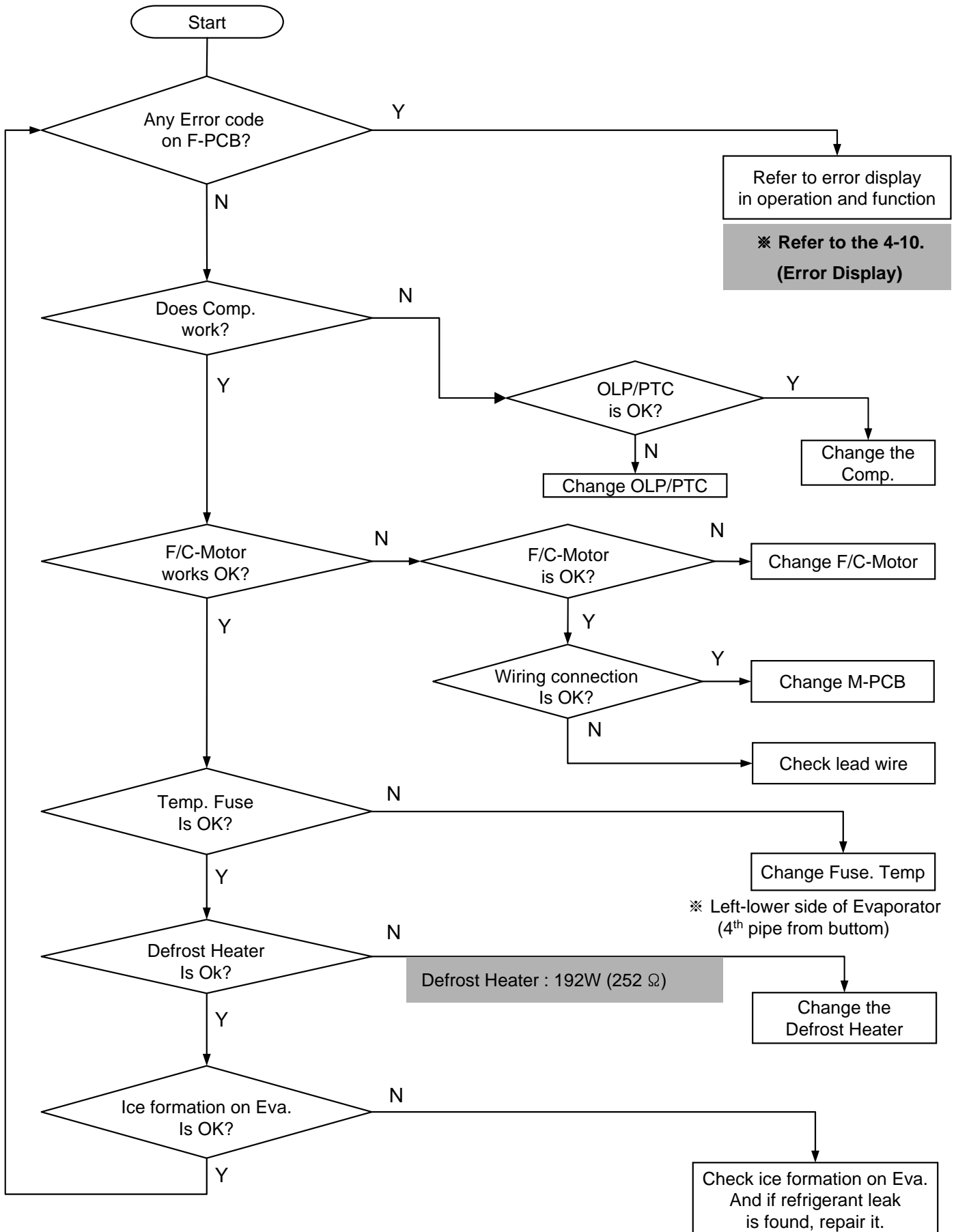

Removing and replacing Freezer parts

(1)



- 1) Remove foods.
- 2) Remove Ice Bucket, shelves and cases in Freezer compartment.

(2)



* Remove 2 screws of Ice Maker.

(4)



* Remove 4 screws of Geared Motor.

(3)



* Remove the Housing of Ice Maker AS. (Right side)

(5)



* Remove the Housing of Geared Motor AS. (Center)

Removing and replacing Freezer parts

(6)

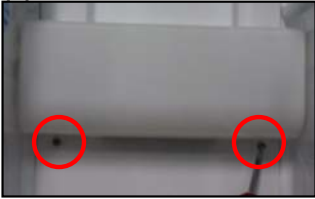

* Remove light cover screws.

(12)



* Remove the screw cap on the F-Louver A with a flat tip driver.

(7)



* Pull down smoothly the bottom of light cover to remove.

(13)



* Remove 3 screws of F-Louver A.

(8)



* Remove the screw of bracket F-Lamp.

(14)



* Hold the end of F-Louver A and pull forward slowly.

(9)



* Remove the left housing.

(15)

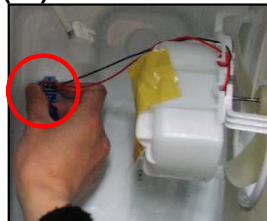

* Remove the housing.

(10)

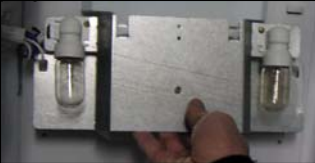

* Pull out smoothly the bracket F-Lamp AS. to remove.

(16)



* Remove the screw of F-Return cover and pull out cover.

(11)



* Hold the end of F-Fan cover and pull forward slowly.

(17)



* Hold the end of F-Louver B and pull forward slowly.

Removing and replacing Freezer parts

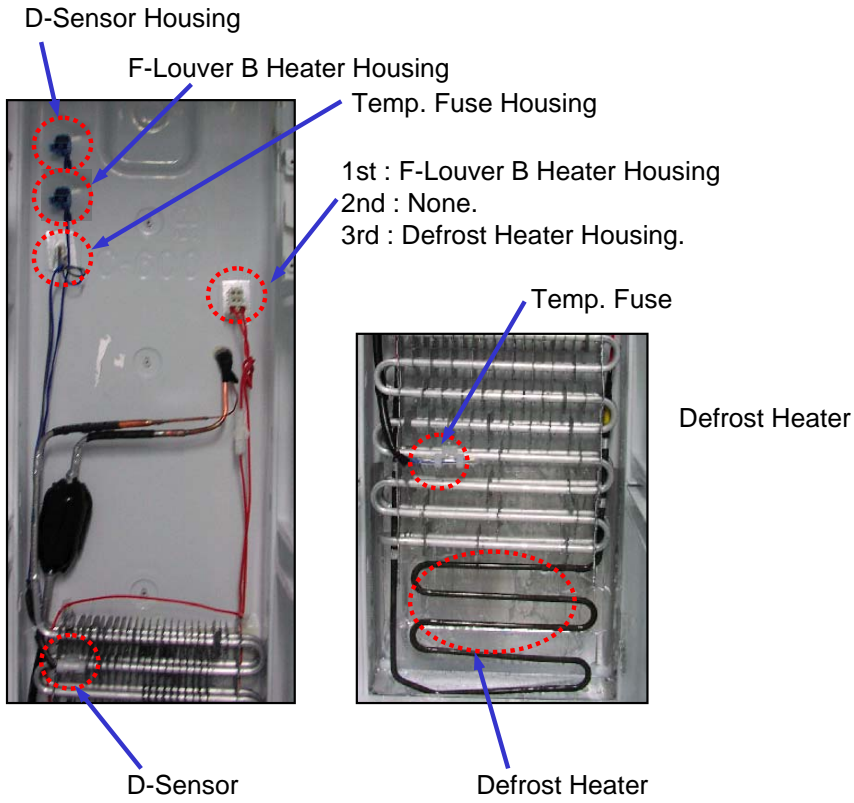

8-2-2. Ice Formation on F-Louver

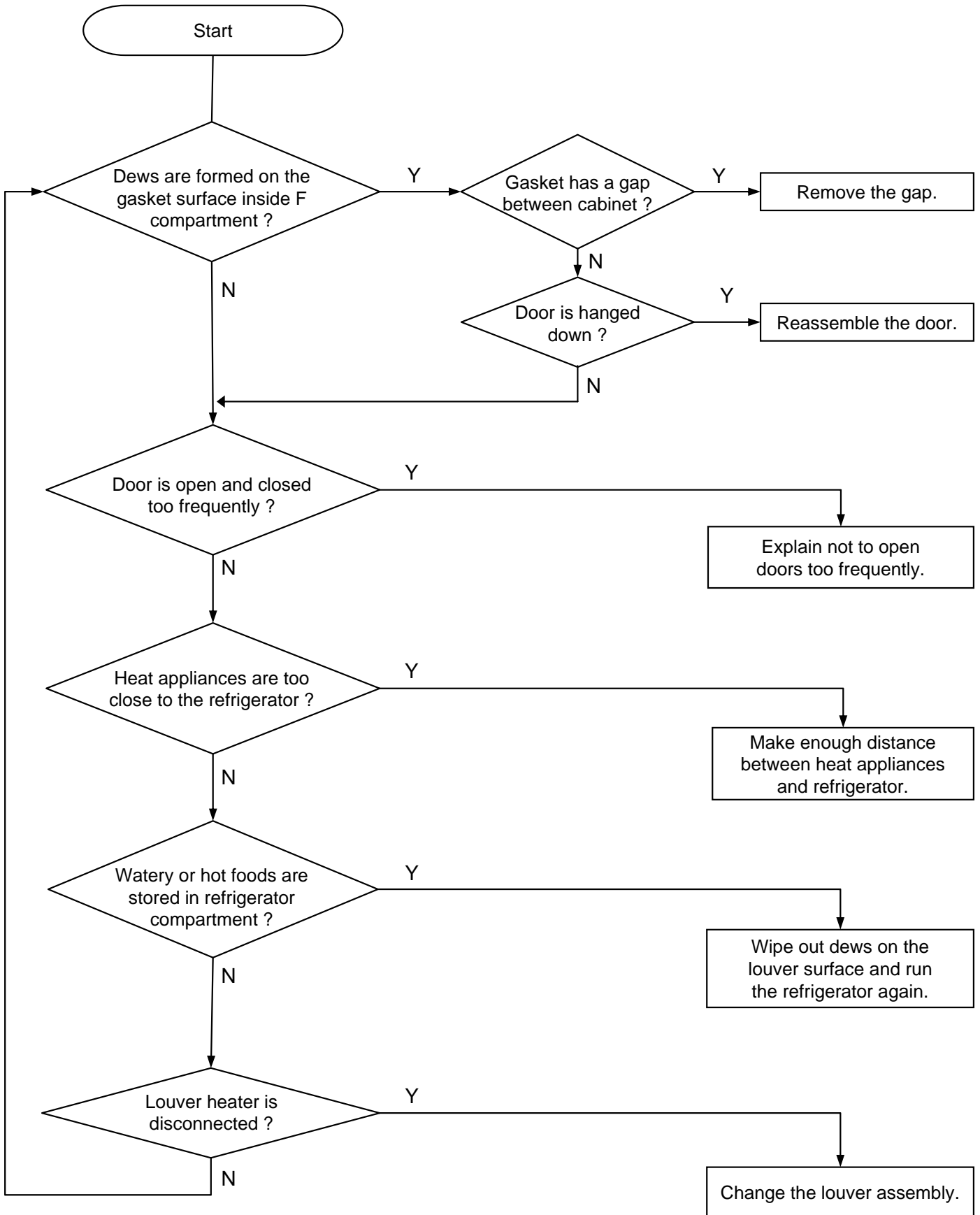

8-2-3. Disconnection / breaking of Freezer Lights Wires

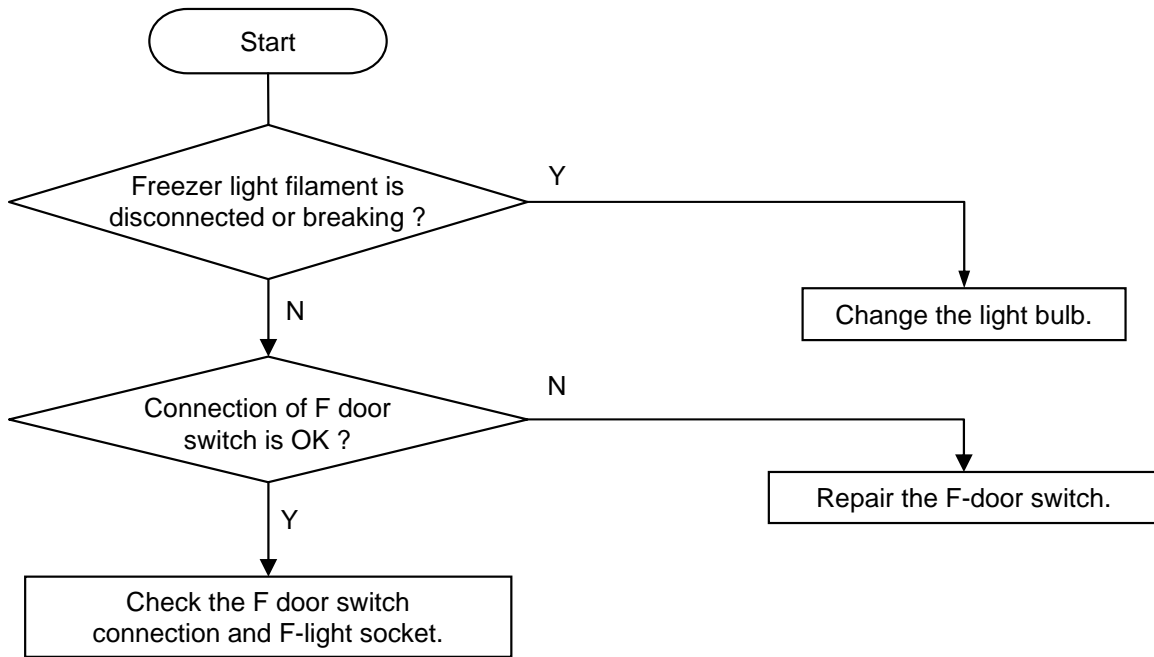

Change of F Lights

Change of F Door Switch



① * Remove 2 screws of light cover.



② * Hold the bottom of light cover and pull forward to remove.



③ * Change the light bulb. (AC240V 25W)

※ Follow the reverse order of disassembling after changing the light.



① * Insert a flat tip screw driver into a gap of door switch to pull forward.

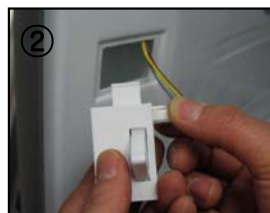

② * Disconnect the housing and change the switch for a new one.

※ Be careful when changing the switch. F and R door switch are different in type and shape.

※ Follow the reverse order of disassembling after changing the switch.

8-3. Refrigerator Compartment

8-3-1. Refrigeration failure (Foods does not get cool or cold soon.)

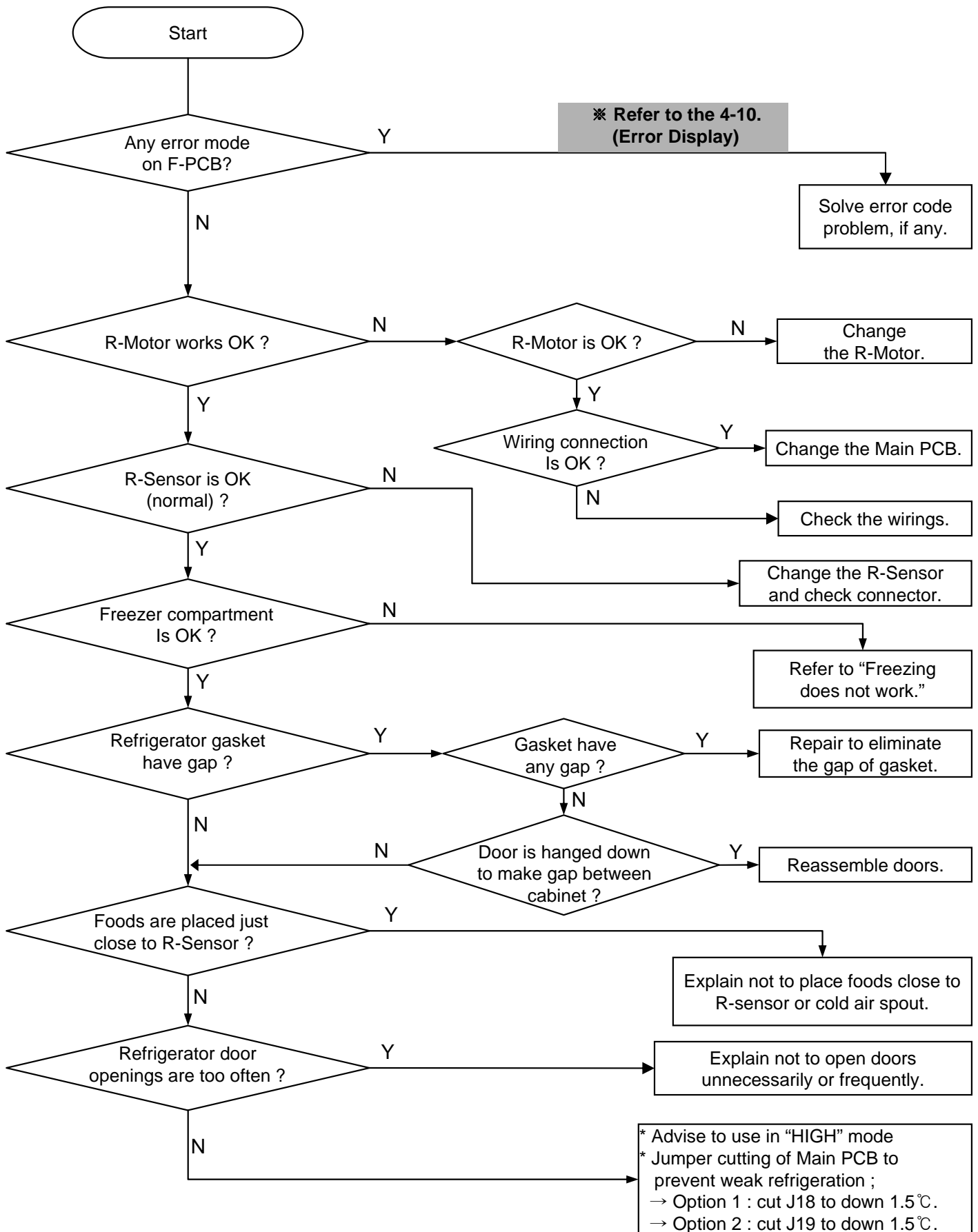

8-3-2. Disconnection / Breaking of Refrigerator Lights Wires

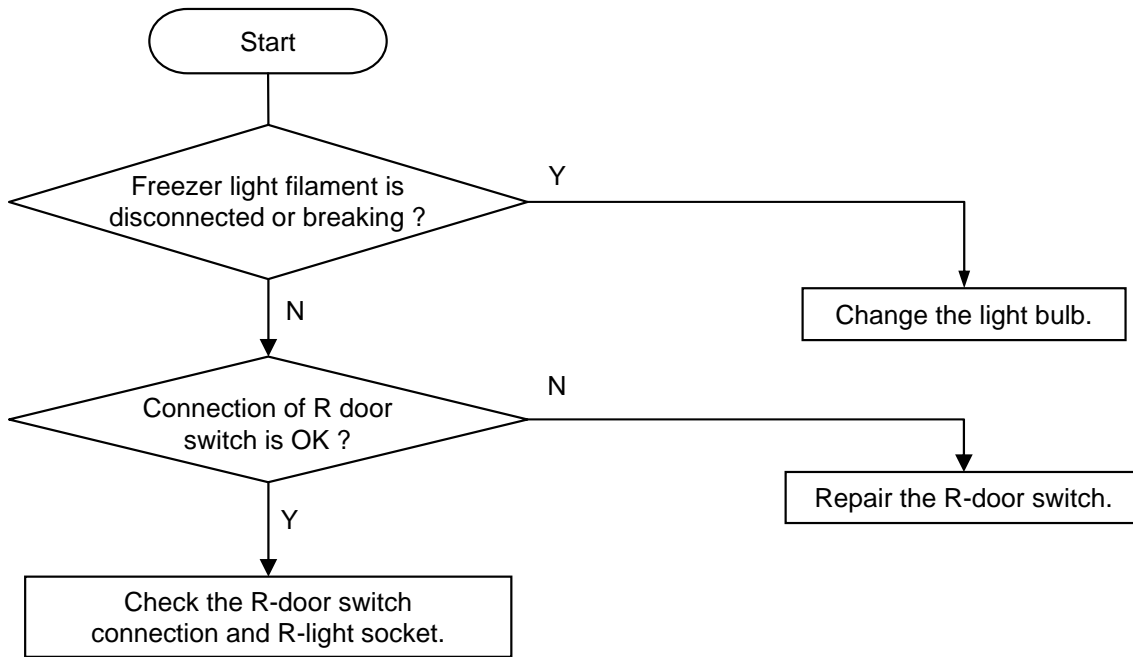

Change of R Lights

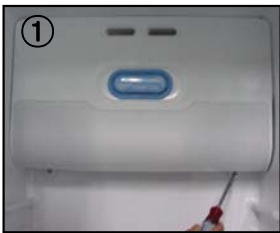

* Remove screws of light cover.



* Hold the bottom of cover and pull forward to remove.



* Change the light bulbs.
(AC240V 25W)

※ Follow the reverse order of disassembling after changing the light.

Change of F Door Switch



* Insert a flat tip screw driver into a gap of door switch to pull forward.



* Disconnect the housing and change the switch for a new one.

※ Be careful when changing the switch. F and R door switch are different in type and shape.

※ Follow the reverse order of disassembling after changing the switch.

8-3-3. Dews on Refrigerator Compartment

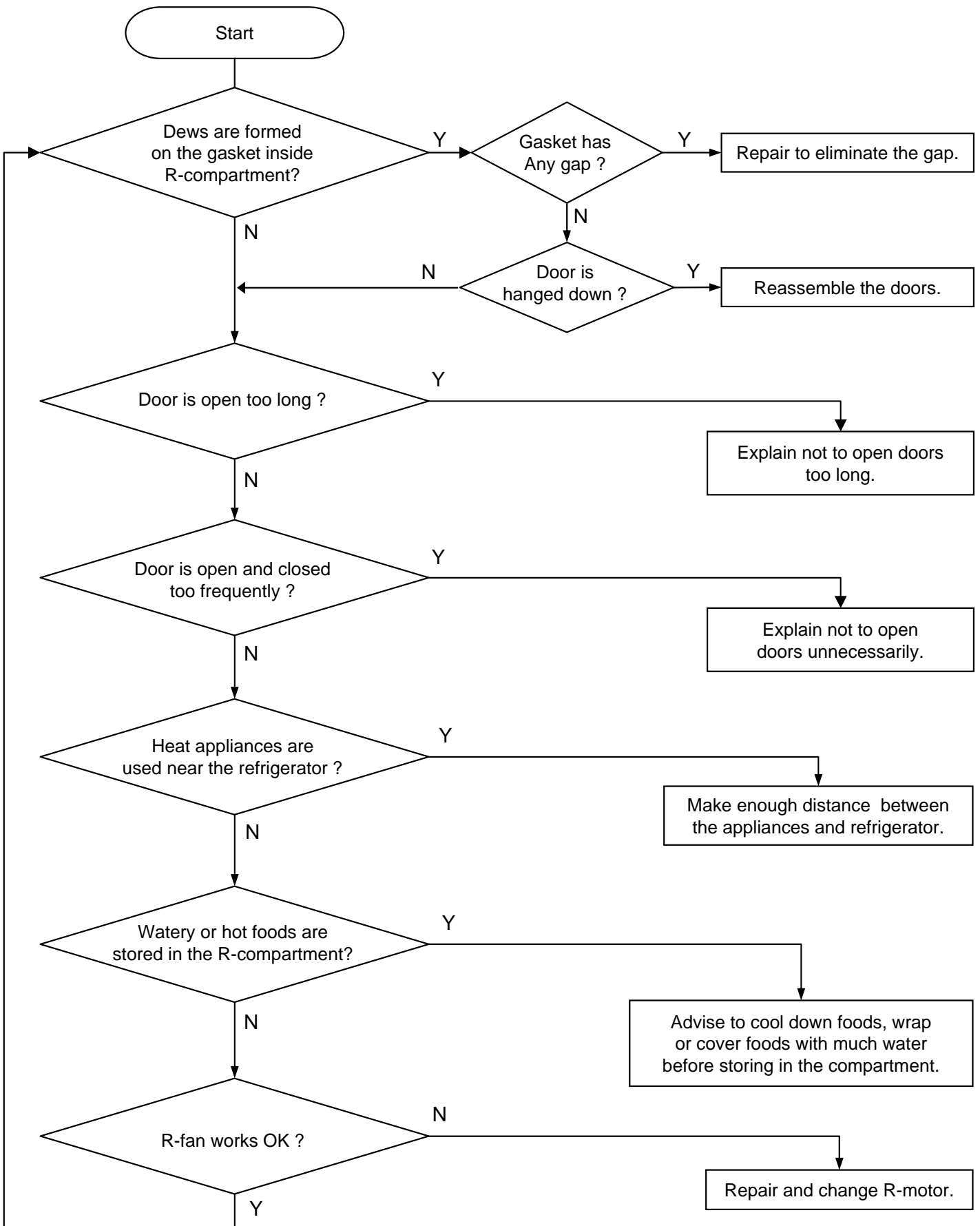

8-3-4. Excessive Refrigeration of Vegetable Case

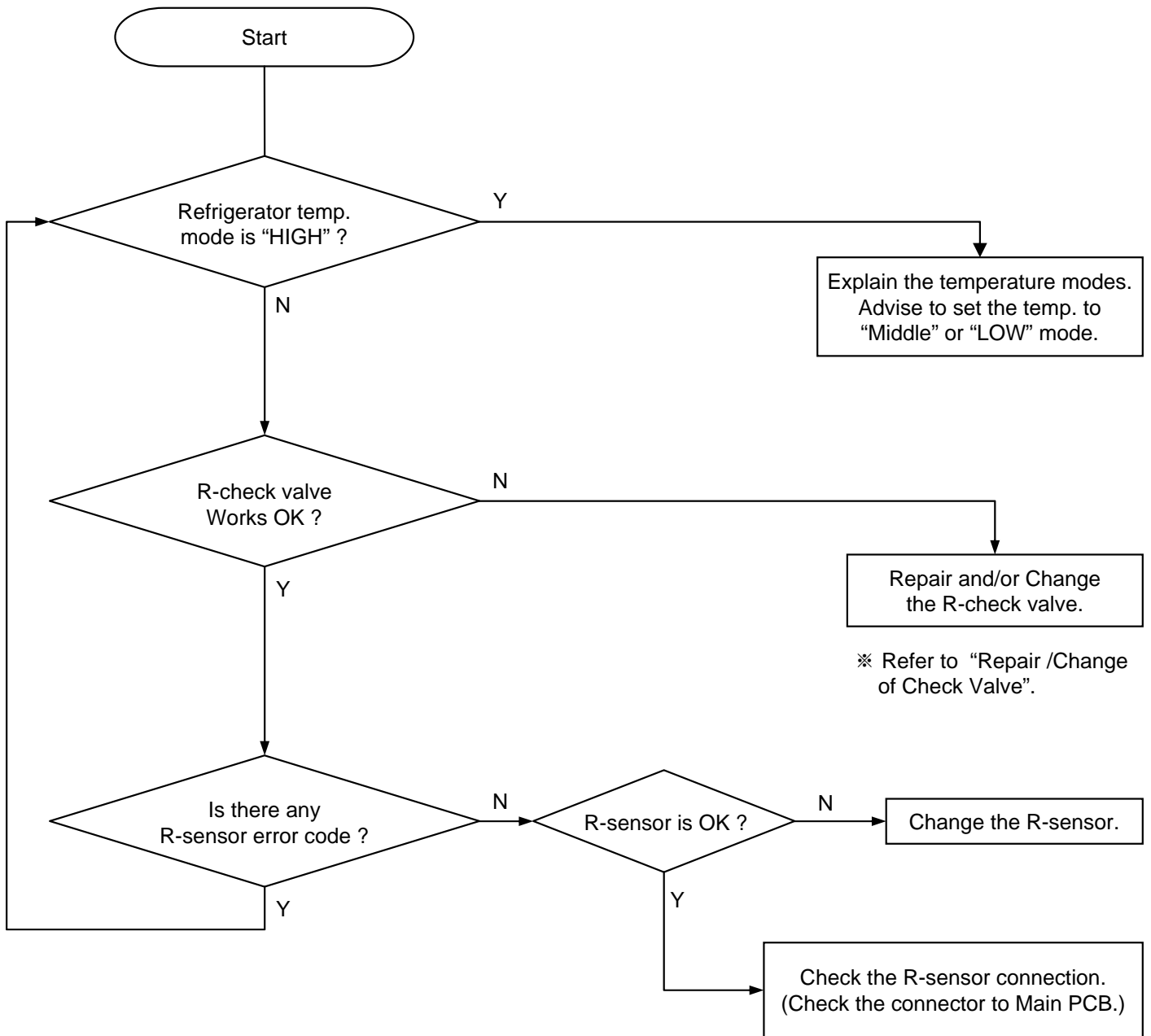

Removing of Check Valve

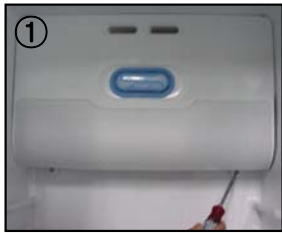

* Remove screws of light cover.



* Hold the bottom and right of damper to pull down to remove.



* Hold the bottom of cover and pull forward to remove.



* Lift up a piece of Check Valve Flap and insert a finger to the valve frame to hold out.



* Disconnect light housing.



* Remove screws with a (+)screw driver.



8-4. Operation Noise of Refrigerator

8-4-1. Comp. operation Noise

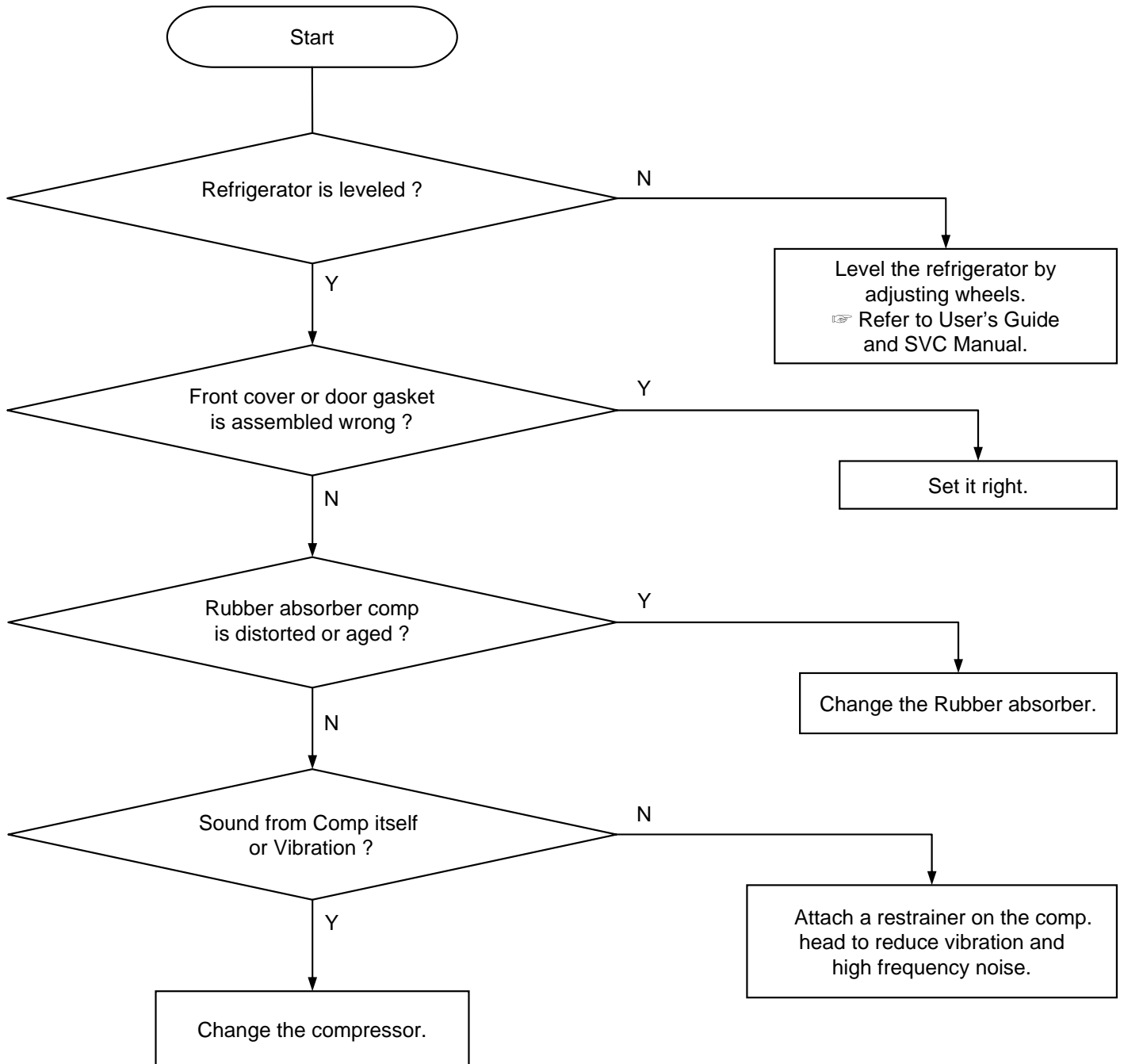

Remarks

- Compressor sound is somewhat normal because it works like a heart to circulate the refrigerant in the pipes during the refrigerator operation.
- Rattling or metallic touch sound of motor, piston of comp. can be heard when it starts or stops.

8-4-2. Refrigerant Flow Sound

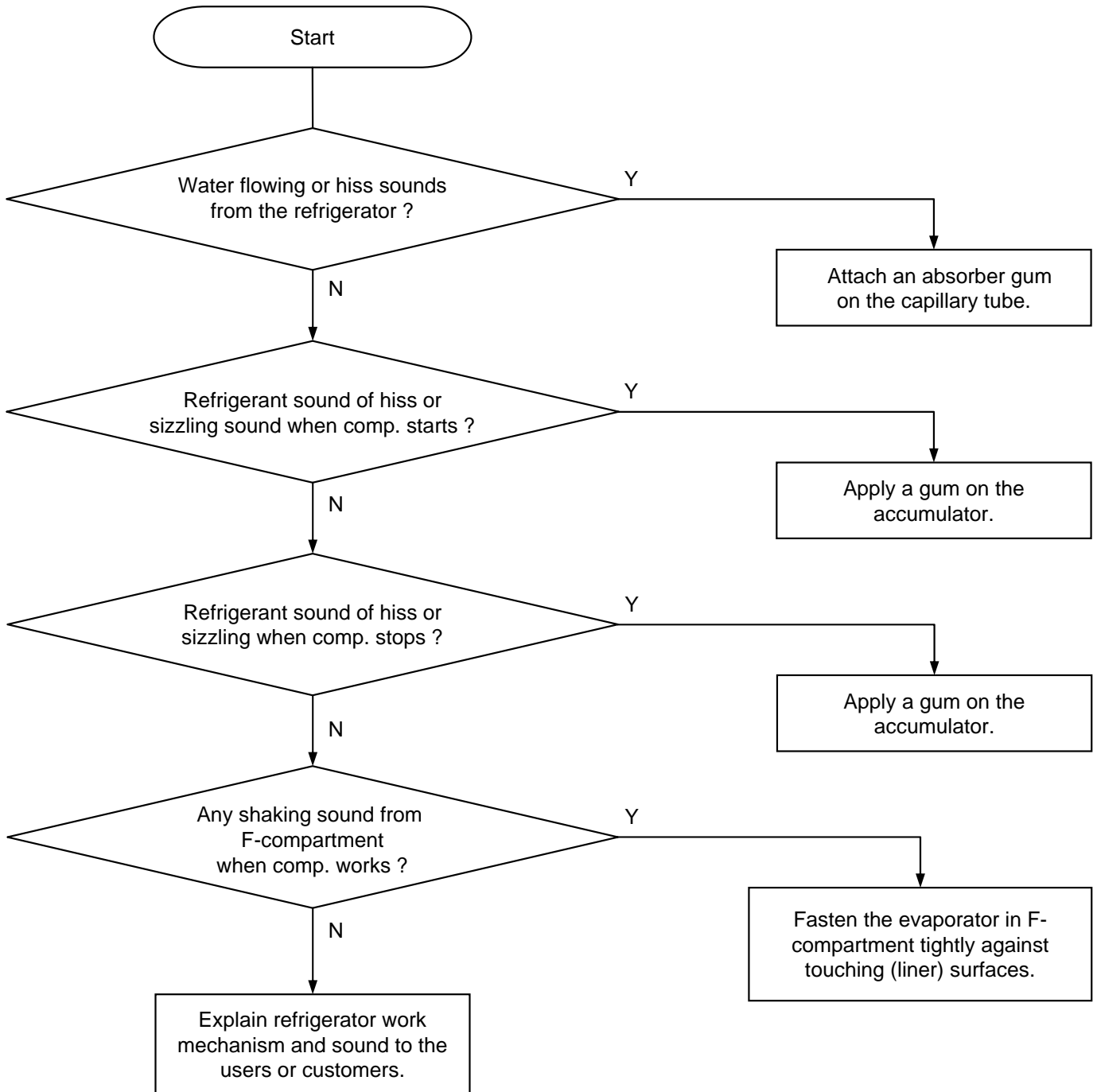

Remarks

● Water flowing sound, hiss or sizzling sound can make while refrigerant in the pipes is changing from liquid to gas state when comp. starts or stops. It is normal to the refrigerator.

Troubleshooting of Evaporator Sound

1. Hiss Sound from Capillary Tube

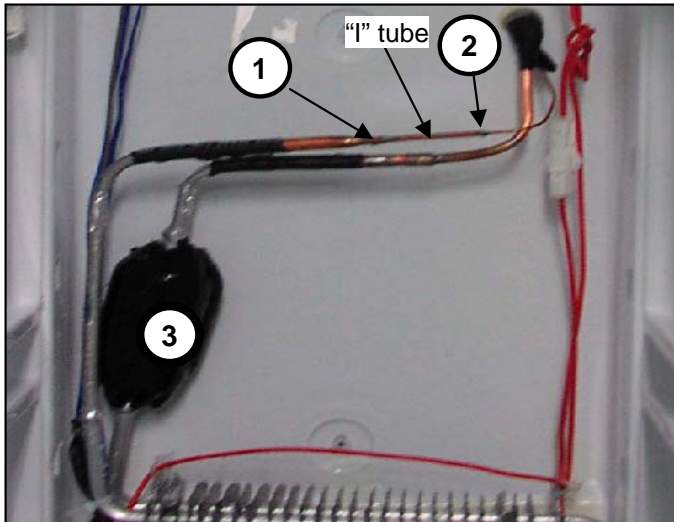

1) "I" tube is used to connect the capillary tube and evaporator.
(2 welding points : ①, ②)

2) When such a sound is made, attach a absorber on the tube including 2 welding points.

2. Sizzling Sound from Accumulator

Attach a absorber on point ③ (accumulator).

3. Shaking or trembling Sound of Evaporator

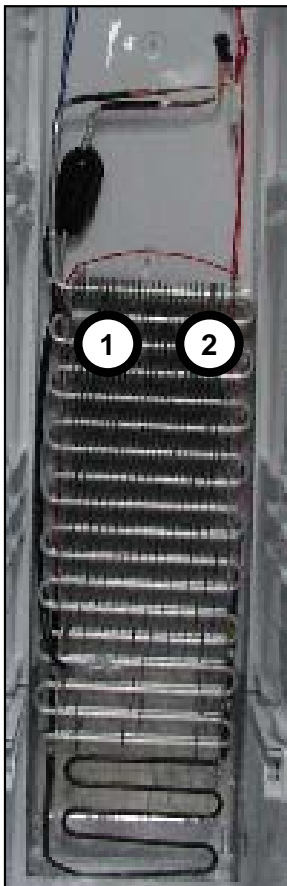

1) Check whether evaporator is fastened tight with the fasteners of ①, ②.

2) Insert a soft spacer (EPS) between left and right wall. Evaporator not to be shaken or trembled during refrigerator operation.

8-4-3. Fan Noise

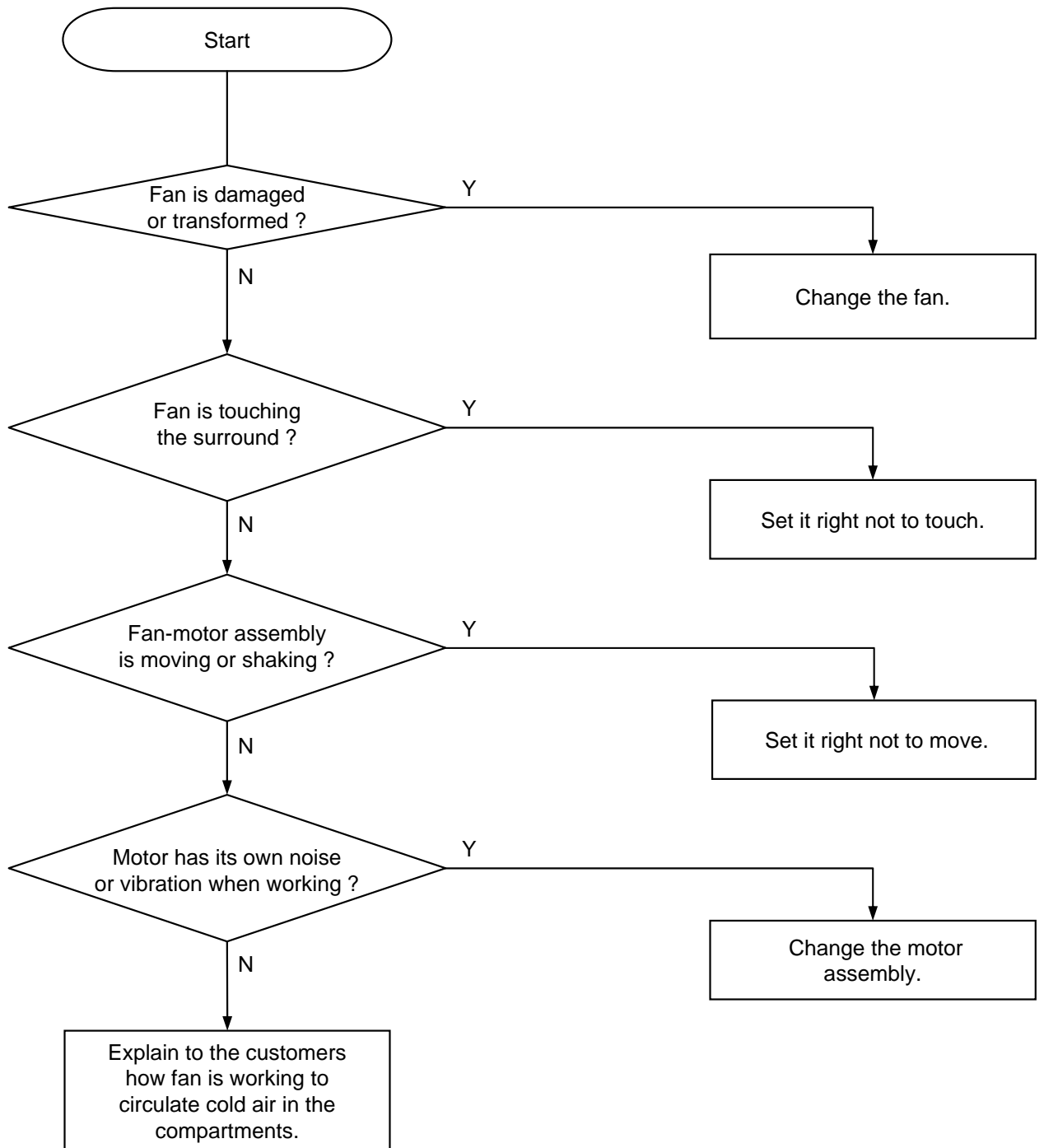

Remarks

● The fan is sending out cold air to circulate it through the compartments.
 When the air is touching the surface of louver or liner wall, such sound can make.

Troubleshooting of Fan Noise

1. Fixing or Fastening of Fan Motor



- 1) Check if fan motor frame of the assembly is fastened tightly with screws to the liner wall. Unless it is tight, vibration of shaking can make.
- 2) Check if fan motor and fan are hanged down. Fan working sound can be louder if they are not set right.

2. Any Touch Sound from Fan



- 1) Check if sealing sponge on the insulator touches the fan. If so, set it again not to touch it.
- 2) If any damage on the insulator around the fan rotation is found, set the fan motor assembly right not to touch it.

8-4-4. Pipe Noise

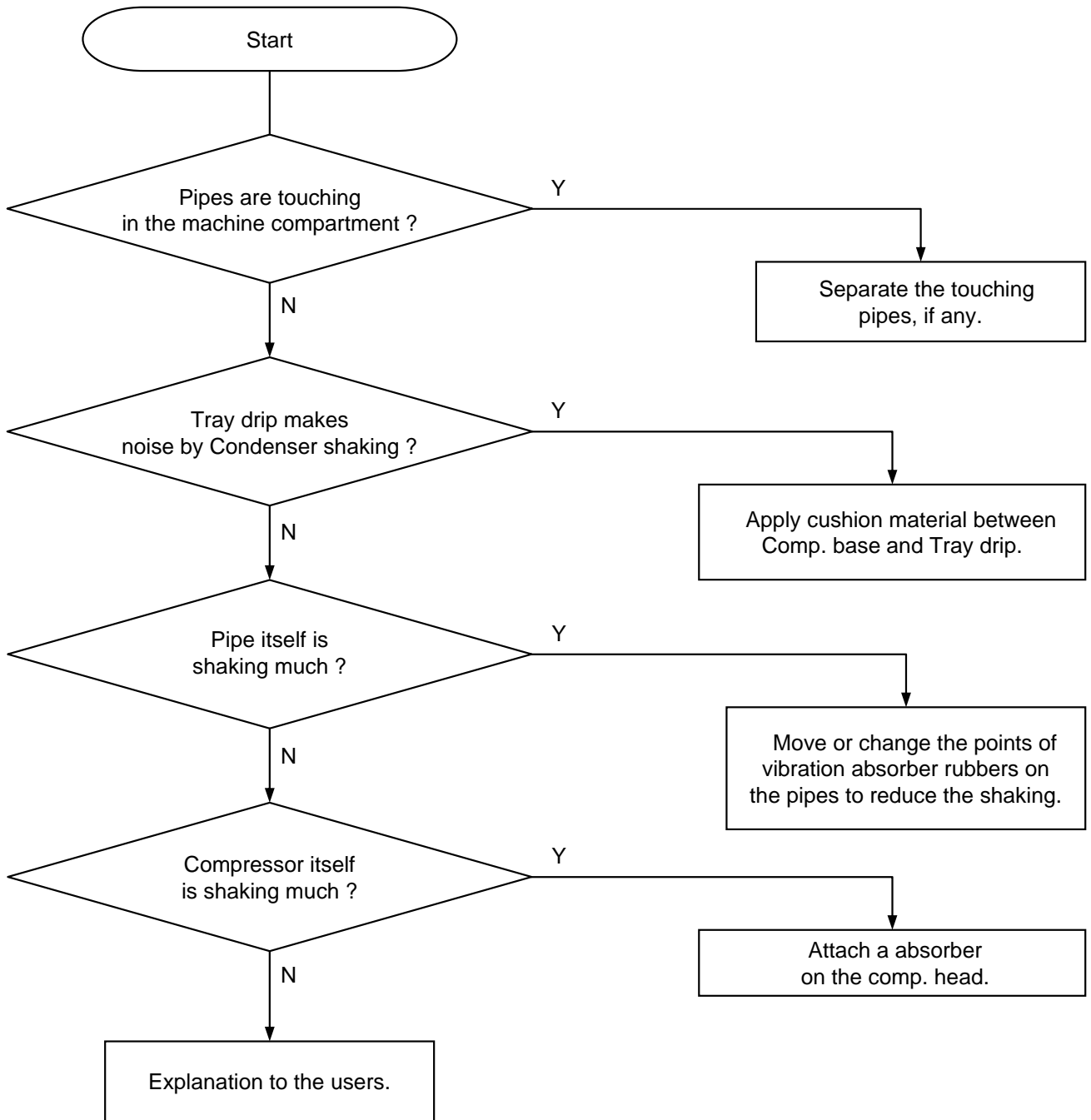

| Remarks |
|--|
| <ul style="list-style-type: none"> ● Refrigerant is erupting rapidly from the compressor to circulate pipes, so pipe shaking noise can make to some degree. ● In case compressor vibration is sent to a pipe directly, apply vibration absorber rubbers to welding points of the pipe and comp. or to a much bent point on the pipe. |

8-5. Door

8-5-1. Door Opening Alarm Continues though the door is closed.

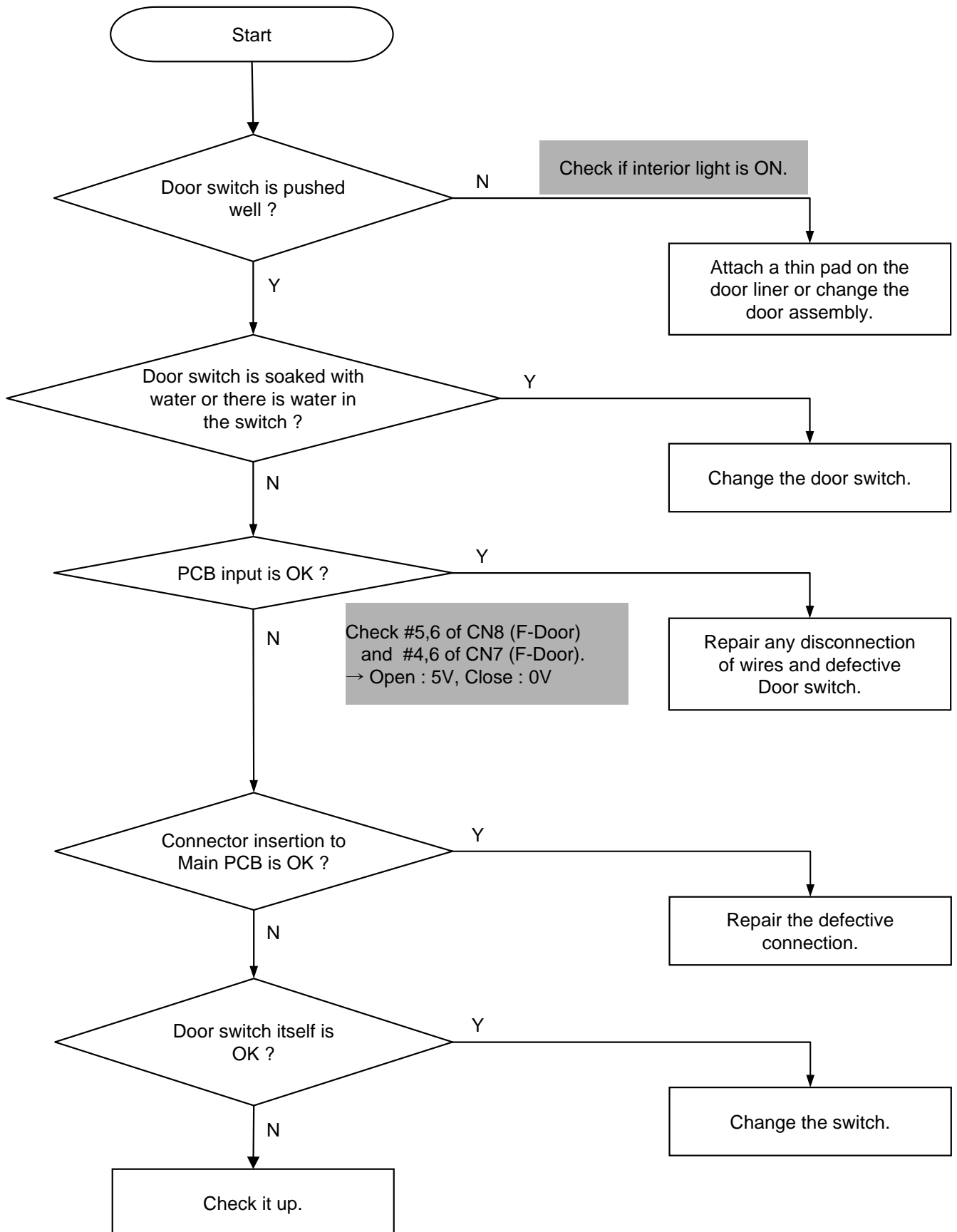

9. COOLING CYCLE HEAVY REPAIR

9-1. Summary of Heavy Repair

| Process | Contents | Tools |
|---|---|---|
| Remove refrigerant Residuals | * Cut charging pipe ends (Comp. & Dryer) and discharge refrigerant from drier and compressor. | * Nipper, side cutters |
| Parts replacement and welding | * Confirm refrigerant (R-134a or R-600a) and oil for compressor and drier. * Confirm N2 sealing and packing conditions before use. Use good one for welding and assembly. * Weld under nitrogen gas atmosphere. * Repair in a clean and dry place. | * Pipe Cutter, Gas welder, N2 gas |
| Vacuum | * Evacuate for more than forty minutes after connecting manifold gauge hose and vacuum pump to high (drier) and low (compressor) pressure sides. | * Vacuum pump , Manifold gauge. |
| Refrigerant charging and charging inlet welding | * Weigh and control the bombe in a vacuum conditions with electronic scales and charge through compressor inlet (Process tube). * Charge while refrigerator operates). * Weld carefully after inlet pinching. | * Bombe (mass cylinder), refrigerant manifold gauge, electronic scales, punching off flier, gas welding machine |
| Check refrigerant leak and cooling capacity | * Check leak at weld joints. Note :Do not use soapy water for check. * Check cooling capacity → Check condenser manually to see if warm. → Check hot pipe manually to see if warm. → Check frost formation on the whole surface of the evaporator. | * Electronic Leak Detector, Driver. |
| Compressor compartment and tools arrangement | * Remove flux from the silver weld joints with soft brusher wet rag. (Flux may be the cause of corrosion and leaks.) * Clean tools and store them in a clean tool box or in their place. | * Copper brush, Rag, Tool box |
| Transportation and installation | * Installation should be conducted in accordance with the standard installation procedure. (Leave space of more than 5 cm from the wall for compressor compartment cooling fan mounted model.) | |

9-2. Precautions During Heavy Repair

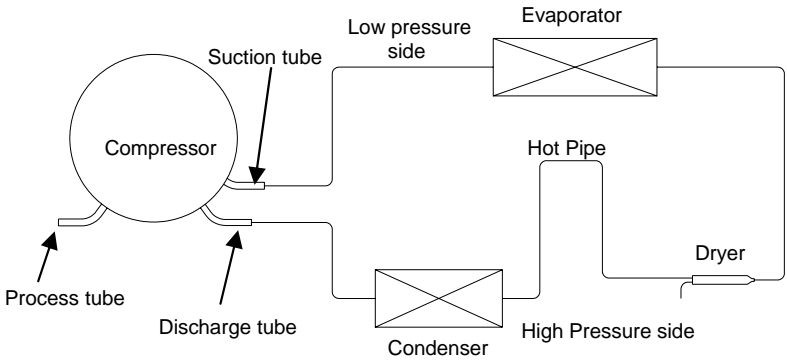
| Items | Precautions |
|----------------------------------|--|
| Use of tools. | 1) Use special parts and tools for R-134a or R-600a |
| Removal of retained refrigerant. | <p>1) Remove retained refrigerant more than 5 minutes after turning off a refrigerator. (If not, oil will leak inside.)</p> <p>2) Remove retained refrigerant by cutting first high pressure side (drier part) with a nipper and then cut low pressure side. (If the order is not observed, oil leak will happen.)</p>  |
| Replacement of drier. | 1) Be sure to replace drier when repairing pipes and injecting refrigerant. |
| Nitrogen blowing welding. | 1) Weld under nitrogen atmosphere in order to prevent oxidation inside a pipe. (Nitrogen pressure : 0.1~0.2 kg/cm2.) |
| Others. | <p>1) Nitrogen only should be used when cleaning inside of cycle pipes inside and sealing.</p> <p>2) Check leakage with an electronic leakage tester.</p> <p>3) Be sure to use a pipe cutter when cutting pipes.</p> <p>4) Be careful not the water let intrude into the inside of the cycle.</p> |

9-3. Practical Work for Heavy Repair

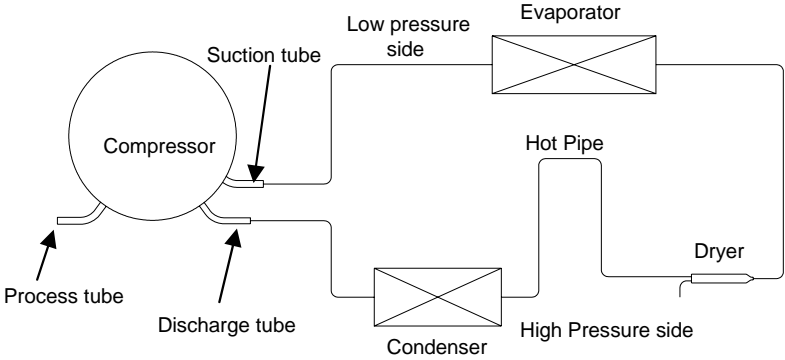
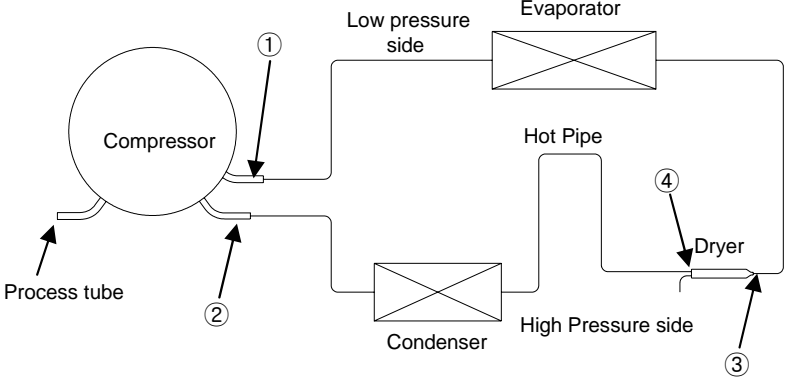
| Items | Precautions |
|--|---|
| <p>1. Removal of residual refrigerant.</p> | <p>1) Remove residual refrigerant more than 5 minutes later after turning off the refrigerator. (If not, compressor oil may leak inside.) 2) Remove retained refrigerant slowly by cutting first high pressure side (drier part) with a nipper and then cut low pressure side.</p>  |
| <p>2. Nitrogen blowing welding.</p> |  <p>* When replacing a drier: Weld ① and ② parts by blowing nitrogen (0.1~0.2kg/cm²) to high pressure side after assembling a drier.</p> <p>* When replacing a compressor: Weld ③ and ④ parts by blowing nitrogen to the low pressure side. Note) For other parts, nitrogen blowing is not necessary because it does not produce oxidized scales inside pipe because of its short welding time.</p> <p>※ KEYPOINTING Welding without nitrogen blowing produces oxidized scales inside a pipe, Which affect on performance and reliability of a product.</p> |

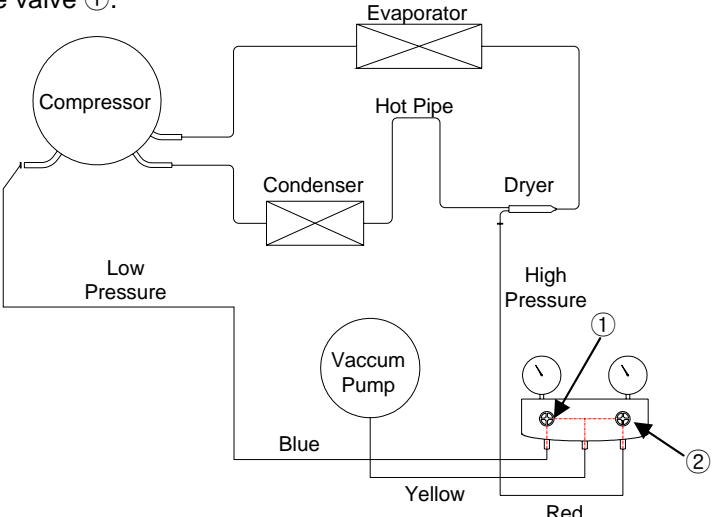
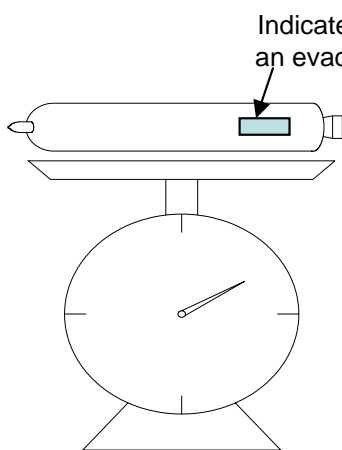
| Items | Precautions |
|--------------------------------|--|
| <p>3.Vacuum degassing.</p> | <p>* Pipe Connection Connect a red hose to the high pressure side and a blue hose to the low pressure side.</p> <p>* Vacuum Sequence Open ①,② valves and evacuate for 40 minutes. Close valve ①.</p>  <p>※ KEYPOINTING</p> <ol style="list-style-type: none"> 1) If power is applied during vacuum degassing, vacuum degassing shall be more effective. 2) Operate compressor while charging refrigerant. (It is easier and more certain to do like this.) |
| <p>4.Refrigerant charging.</p> | <p>* Charging sequence</p> <ol style="list-style-type: none"> 1) Check the amount of refrigerant supplied to each model after completing vacuum degassing. 2) Evacuate bombe with a vacuum pump. 3) Measure the amount of refrigerant charged. <ul style="list-style-type: none"> - Measure the weight of an evacuated bombe with an electronic scale. - Charge refrigerant into a bombe and measure the weight. Calculate the weight of refrigerant charged into the bombe by subtracting the weight of an evacuated bombe.  <p>※ KEYPOINTING</p> <ol style="list-style-type: none"> 1) Be sure to charge the refrigerant at around 25°C. 2) Be sure to keep -5g in the winter and +5g in summer. <p>Calculation of amount of refrigerant charged</p> <p>the amount of refrigerant charged = a weight after charging - a weight before charging (a weight of an evacuated cylinder)</p> |

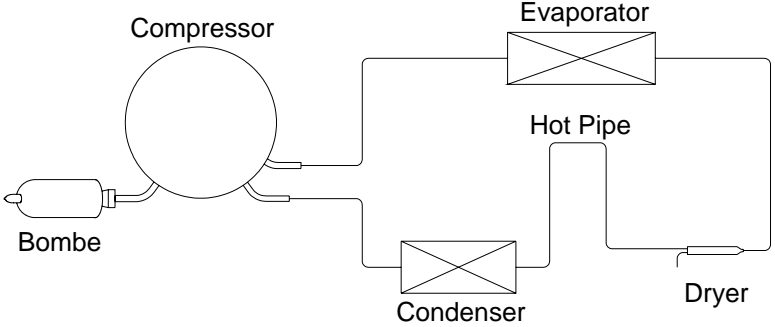
| Items | Precautions |
|-----------------------------------|--|
| 4.Refrigerant charging. | <p>4) Refrigerant Charging Charge refrigerant while operating a compressor as shown above. 5) Pinch a charging pipe with a pinch-off plier after completion of charging. 6) Braze the end of a pinched charging pipe with copper brazer and take a gas leakage test on the welded parts.</p>  |
| 5. Gas-leakage test | * Take a leakage test on the welded or suspicious area with an electronic leakage tester. |
| 6. Pipe arrangement in each cycle | * Check each pipe is placed in its original place before closing a cover back-M/C after completion of work. |

9-4. Standard Regulations for Heavy Repair

| |
|---|
| <ol style="list-style-type: none"> 1) Observe the safety precautions for gas handling. 2) Use JIG (or wet towel) in order to prevent electric wires from burning during welding. (In order to prevent insulation break and accident.) 3) The inner case shall be melted and insulation material (polyurethane) shall be burnt if not cared during welding inner case parts. 4) The copper pipe shall be oxidized by overheating if not cared during welding. 5) Not allow the aluminum pipes to contact to copper pipes. (In order to prevent corrosion.) 6) Make sure that the inner diameter should not be distorted while cutting a capillary tube. 7) Be sure that a suction pipe and a filling tube should not be substituted each other during welding. (High efficiency pump.) |
|---|

9-5. Brazing Reference Drawings.

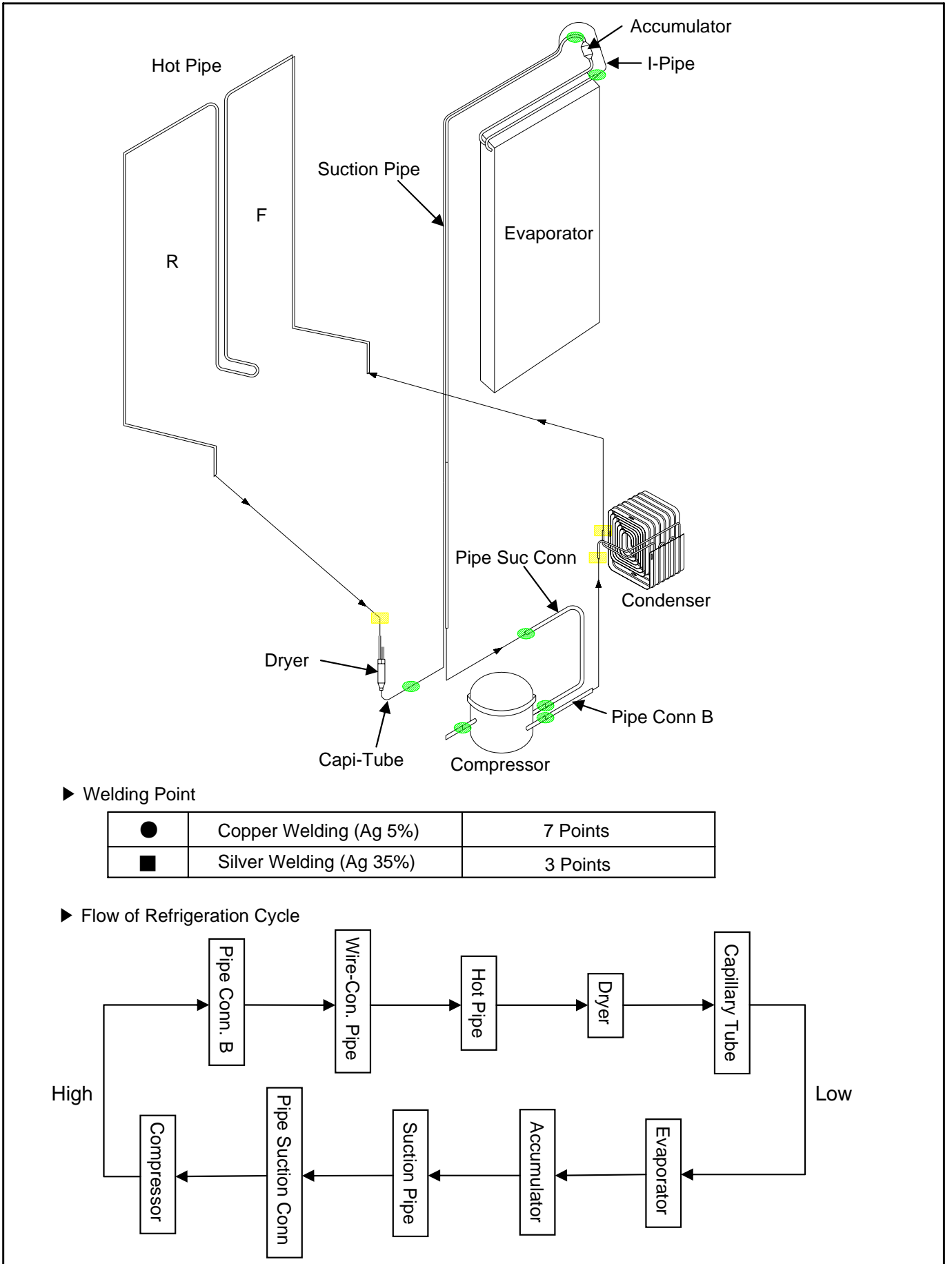

10. INSTALLATION GUIDE

10-1. Installation Preparation

Check if the refrigerator can pass a doorway or enter a door first.

| | |
|-------------------------------------|--------------------------|
| Dimensions(including Door Handles) | |
| (Width*Depth*Height) | 903mm X 734.5mm X 1790mm |

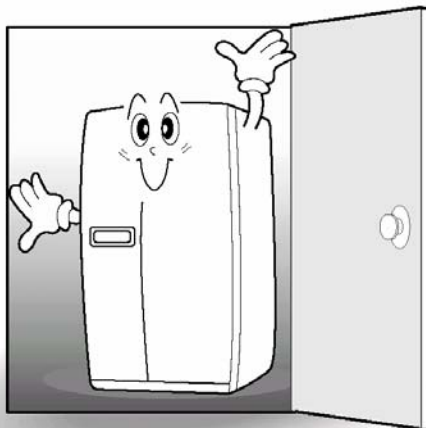

Find a suitable place to install

Sufficient space from refrigerator back to the
* wall for free air ventilation

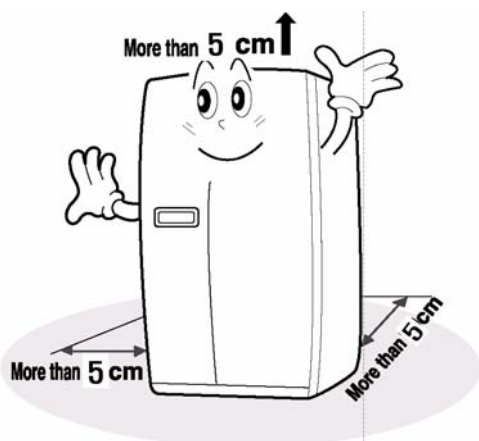

* Avoid direct sunlight.

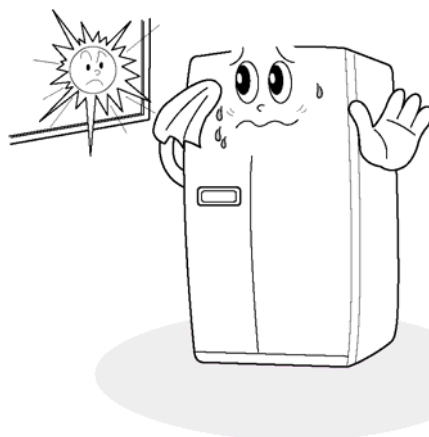

Once the installation place is ready follow the installation instructions.
If surround temperature of refrigerator is low (below 10°C)),
foods can be frozen or the refrigerator can work in abnormal way.

10-2. If the refrigerator can not enter the door

Removing Freezer Door

※ Remove front bottom cover first, if it is attached.

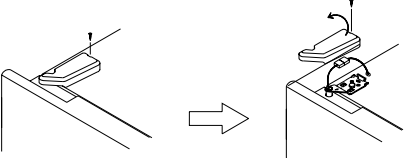
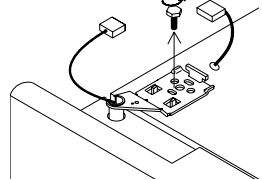
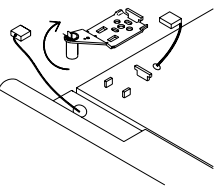
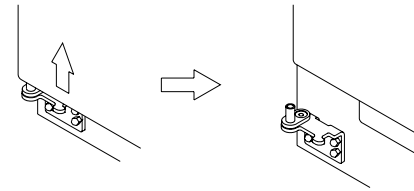
| | | |
|--|---|---|
| <p>1 Remove front bottom cover first, Pull out the left collar of the coupling first, then hold the coupling and pull out the left water tube. (Dispenser Models)</p>  | <p>2 Unscrew top hinge cover with a screw driver. Remove the hinge cover.</p>  | <p>3 Turn top hinge bolt counterclockwise. Disconnect the harness wires.</p>  |
| <p>4 Lift up the front of hinge to remove. (After the hinge is removed the door can fall down forward. Be careful !)</p>  | <p>5 Be careful not to damage the water line when removing the door.</p>  | |

Removing Refrigerator Door

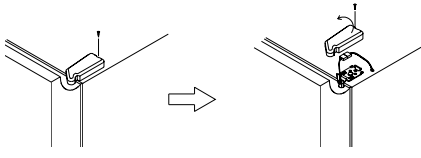
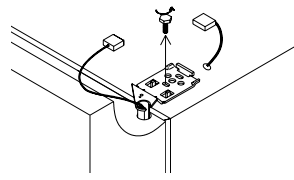
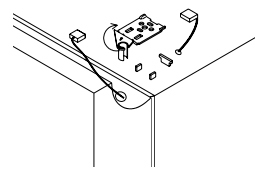
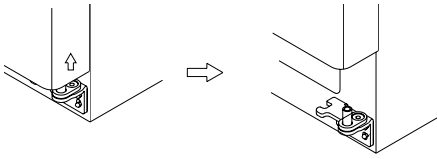
| | | |
|--|---|---|
| <p>1 Unscrew top hinge cover with a screw driver. Remove the hinge cover.</p>  | <p>2 Turn top hinge fastener counterclockwise. Disconnect harness wires.</p>  | <p>3 Lift up the front of hinge to remove. (After the hinge is removed the door can fall down forward. Be careful !)</p>  |
| <p>4 Lift the door straight up to remove.</p>  | | |

Replacing Freezer Door

- 1** Insert the water tube into the hole of the bottom hinge pin first (Dispenser Models). Insert the bottom of freezer door into the bottom hinge pin.

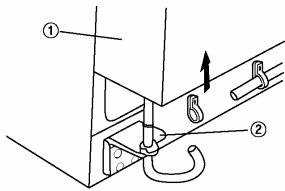

- 2** Insert the bottom hole of freezer door straight to the bottom hinge pin.

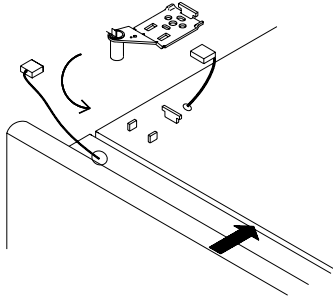

- 3** Let the top of door close to the cabinet and insert the top hinge pin to the top hole of freezer door. (Insert the back of hinge to the groove of protrusion first, then front to the top hole of door.)

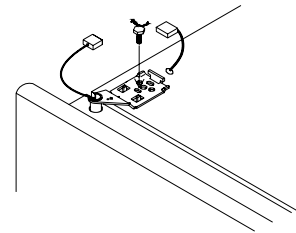

- 4** Turn the hinge fastener tightly to the end. Connect harness wire and screw ground wire.

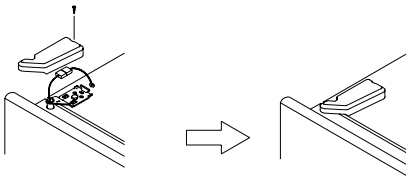

- 5** Insert the water tube far into the coupling. (Dispenser Model)



Replacing Refrigerator Door

- 1** Insert the bottom hole of refrigerator door straight to the bottom hinge pin.

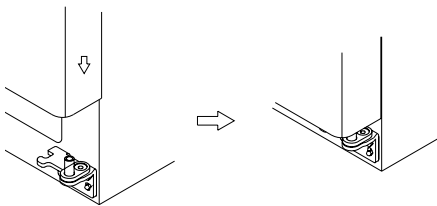

- 2** Let the top of door close to the cabinet and insert the top hinge pin to the top hole of refrigerator door. (Insert the back of hinge to the groove of protrusion first, then front to the top hole of door.)

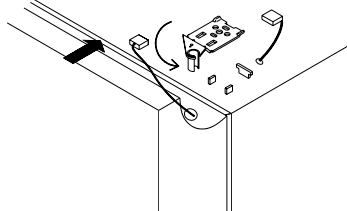

- 3** Turn the hinge fastener tightly to the end. Connect harness wirings and screw ground wire. Click and screw the top hinge cover.

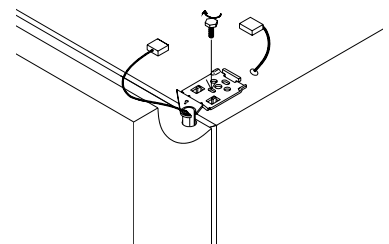

10-3. Refrigerator Leveling & Door Adjustment

※ Refrigerator must be level in order to maintain optimal performance and desirable front appearance.
(If the floor beneath the refrigerator is uneven, freezer and refrigerator doors look unbalanced.)

In case freezer door is lower than refrigerator door

Insert a screw driver (flat tip) into a groove of the left wheel (bottom of freezer) and turn it clockwise until the door is balanced.
(clockwise to raise freezer door ;
counterclockwise to lower)

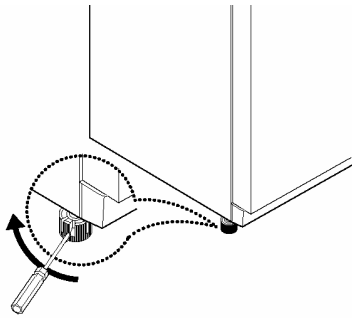

In case refrigerator door is lower than refrigerator door

Insert a screw driver (flat tip) into a groove of the right wheel (bottom of refrigerator) and turn it clockwise until the door is balanced.
(clockwise to raise refrigerator door ;
counterclockwise to lower)

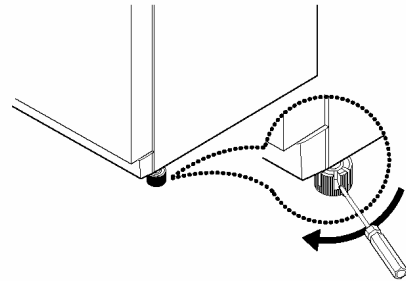

Caution

The front of refrigerator needs to be higher just a little than the back for easy door closing, but if the wheel is raised too much for door balance, i.e. front of refrigerator is too higher than the back, it can be difficult to open the door.

10-4. Water Line Installation

How to install Water Line

- The water pressure should be 3kgf/cm² or more to run the automatic icemaker.
 ※ Checkup your tap water pressure ; if a cup of 180cc is full within 10 seconds, the pressure is OK.
- When installing the water tubes, ensure they are not close to Any hot surface.
- The water filter only "filters" water ; it does not eliminate any bacteria or microbes.
- If the water pressure is not so high to run the icemaker, call the local plumber to get an additional water pressure pump.
- The filter life depends on the amount of use. We recommend you replace the filter at least once every 6months.
 ※ When attaching the filter, place it for easy access (removing & replacing)
- After installation of refrigerator and water line system, select [WATER] on your control panel and press it for 2~3 minutes to supply water into the water tank and dispense water.
- Use sealing tape to every connection of pipes/tubes to ensure there is no water leak.
- The water tube should be connected to the cold water line.

WATER SUPPLY KIT

※ Check the parts below for installing water supply. Some other necessary parts are available at your local service agents.



Connector
(3014454520)



Holder
(3012020700)



Screw x 4ea
(7112401211)



Fastener A x 3ea
(3011202000)



Filter Box
(3019974100)



Water tube A/B
(A:3019503200
B:3019503300)

Installation Procedure

- Join connector to water tap

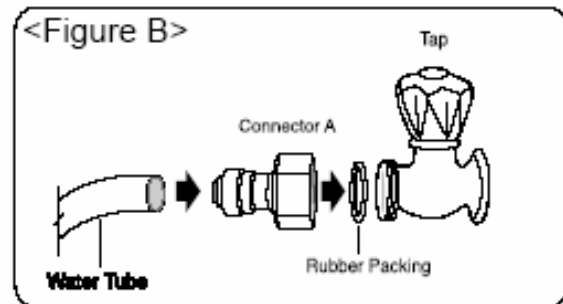
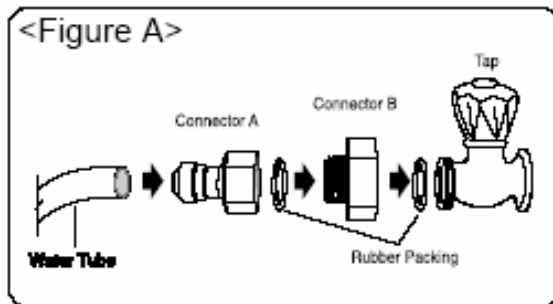

Place the rubber washer inside the tap connector and screw onto the water tap.

- Get ready to install water line

- 1) Measure an approximate distance between the filter and the Water Tube and cut the tube off filter vertically.
- 2) Connect the tubes to the filter as the figure shows.

Leave a sufficient distance when cutting the tubes.

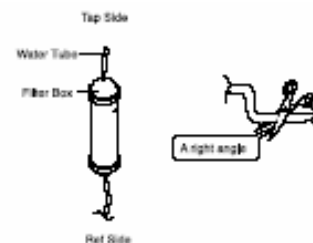

3. Remove any substance from filter

- 1) Open the main tap water valve and check if water comes out of the Water Tube.
- 2) Check if the Water Valve is open in case water does not come out.
- 3) Leave the valve open until clean water is coming out.
※ Initial water may contain some substances out of filter (manufacturing process).

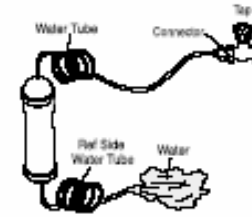

4. Attach the filter box

- 1) Screw and fasten the filter holder to the left/right side of the back of refrigerator.
※ In case the holder is not fastened well, remove the back paper of the tape on the filter holder and attach it.
- 2) Insert the filter box into the holder.

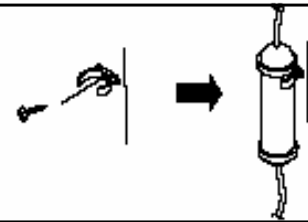

5. Connect water tube

- 1) Remove the rear cover at the bottom back of the refrigerator.
- 2) Insert the fastening ring into the Water tube.
(Be careful to follow the direction of the nut.)
- 3) Insert the Water Tube into the top of Water Valve, turn the nut clockwise to fasten it. (The Water valve is to the right of the motor.)
- 4) Check for any bent tubes or water leaks; if so, re-check installation procedure.
- 5) Replace the rear cover. (The Water Tube should be placed between the groove of the refrigerator back and motor cover.)

Set the tube upright as the figure shows.

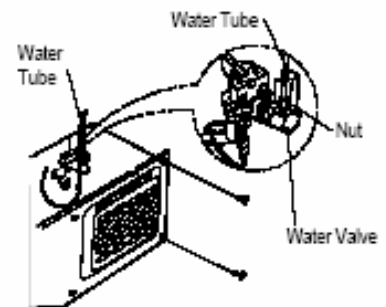

6. Fasten water tube

- 1) Fasten the Water Tube with the [Fastener A].
- 2) Check if the tube is bent or squeezed. If so, set it right to prevent any water leak.

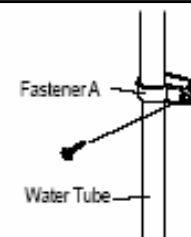

7. After installation

- 1) Plug the refrigerator, press the [WATER] button on the control panel for 2~3 minutes to remove any air (bubble) in the pipes and drain out the initial water.
- 2) Check the water leak again through the water supply system (tubes, connectors and pipes) Rearrange the tubes again and do not move the refrigerator.

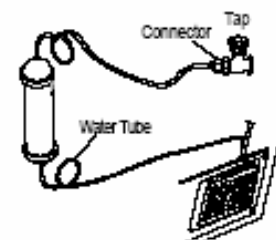

10-5. Dispenser Water Flow

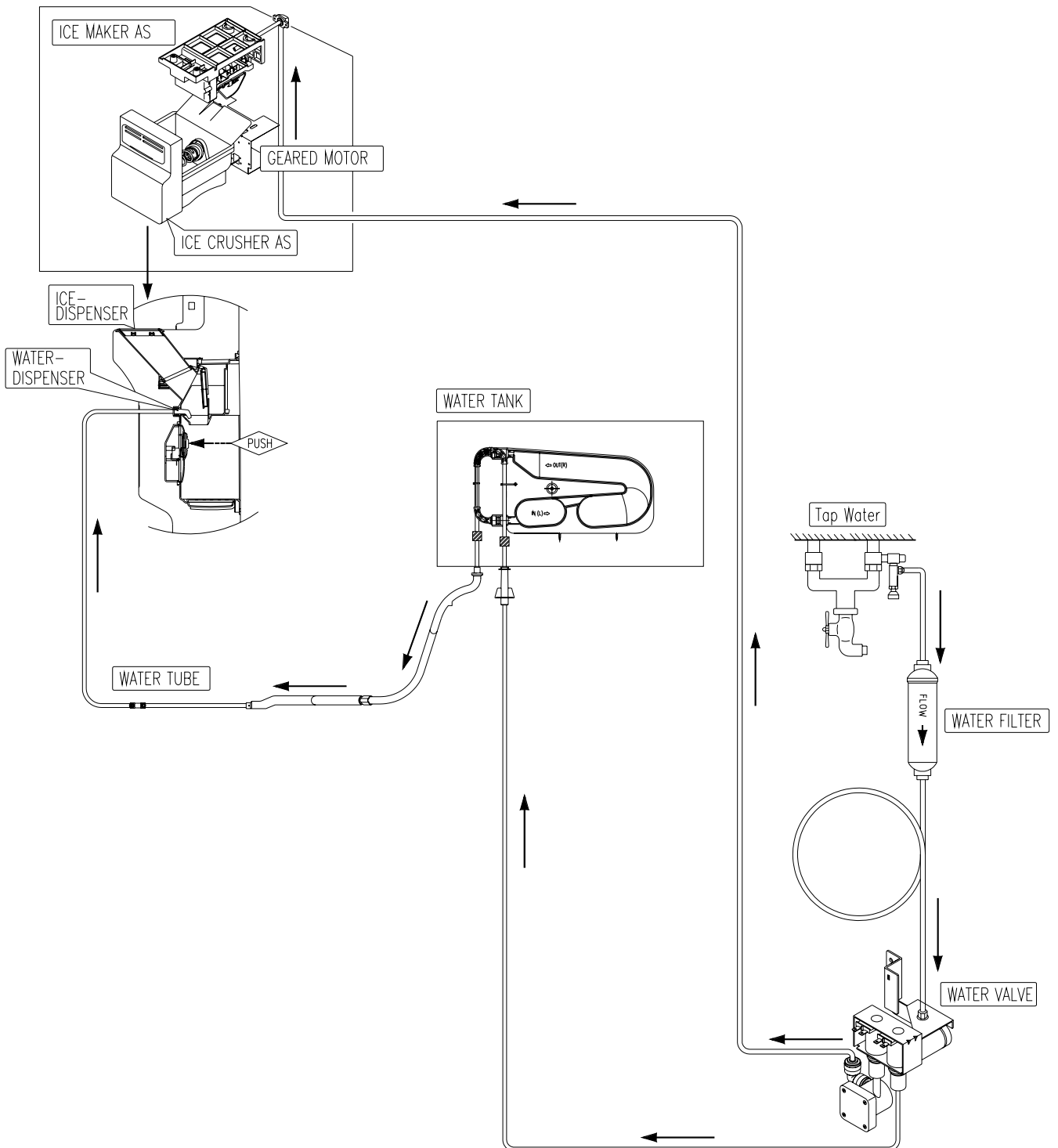

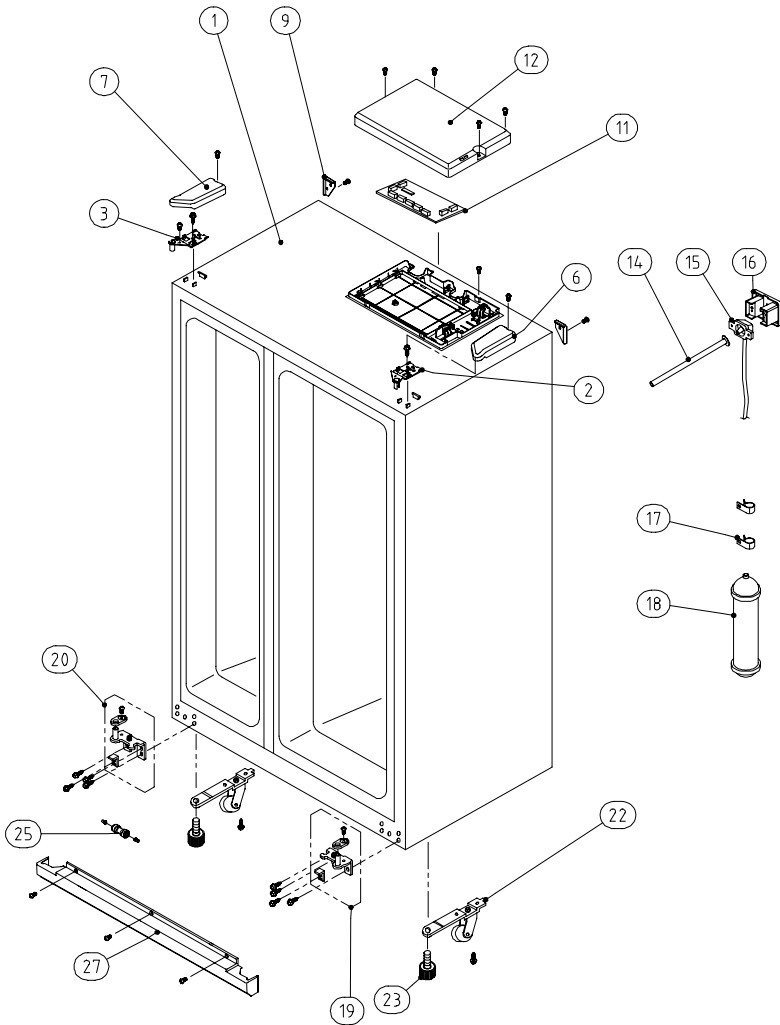

| NO | PART-CODE | PART NAME | SPEC. | Q'ty | | | |
|----|------------|--------------------------|----------------------|------|------|---------|---------|
| | | | | 201E | 20BE | 20D(E)E | 20F(G)E |
| 1 | | ASSY CAB URT | | 1 | 1 | 1 | 1 |
| 2 | 3012924400 | HINGE *T *R AS | PO T3.0+PAINT | 1 | 1 | 1 | 1 |
| 3 | 3012924300 | HINGE *T *L AS | PO T3.0+PAINT | 1 | 1 | 1 | 1 |
| 6 | 3011446200 | COVER HI *T *R | PP | 1 | 1 | 1 | 1 |
| 7 | 3011446100 | COVER HI *T *L | PP | 1 | 1 | 1 | 1 |
| 9 | 3010968400 | CAP CAB COVER | PP | 2 | 2 | 2 | 2 |
| 11 | 30143D6061 | PCB MAIN AS | INNER BASIC (R-134a) | 1 | X | X | X |
| | 30143E1020 | | BASIC (R-134a) | X | 1 | X | X |
| | 30143E1060 | | BASIC (R-600a) | X | | X | X |
| | 30143D5072 | | FRU-541F (R-134a) | X | X | 1 | 1 |
| | 30143D5062 | | FRU-541F (R-600a) | X | X | | |
| 12 | 3011446001 | COVER M/PCB BOX | PP(FB-72) | 1 | 1 | 1 | 1 |
| 14 | 3013224800 | HOSE I/MAKER TUBE AS | FRU-541D | | | 1 | 1 |
| 15 | 3012519210 | GUIDE CAB W/TUBE A AS | L1525 | | | 1 | 1 |
| 16 | 3011444100 | COVER GUIDE CAB W/TUBE A | PP | X | X | 1 | 1 |
| 17 | 3011202000 | CLAMP TUBE | PA-66,5N | | | 2 | 2 |
| 18 | 3019974800 | S/PART FILT WATER AS | FR-S660CW/CD | | | 1 | 1 |
| 19 | 3012924003 | HINGE *U *R AS | P/O T5.0+PAINT | 1 | 1 | 1 | 1 |
| 20 | 3012923902 | HINGE *U *L AS | P/O T5.0+PAINT | 1 | 1 | 1 | 1 |
| 22 | 3010657201 | BRACKET ADJ FOOT | SPCC T2.6 | 2 | 2 | 2 | 2 |
| 23 | 3012105100 | FOOT ADJ AS | PP | 2 | 2 | 2 | 2 |
| 25 | 3013064200 | HOLDER TUBE A | A5UC5 | X | X | 1 | 1 |
| 27 | 3011447200 | COVER CAB BRKT | PP | 1 | 1 | 1 | 1 |

- Some parts can be chaged for improving their perfomance without notice.
 - Above parts number doesn't describe your own colour & printing. Please remind!

| Date | A mendment Note |
|------|-----------------|
| | |
| | |
| | |
| | |
| | |
| | |
| | |
| | |
| | |
| | |

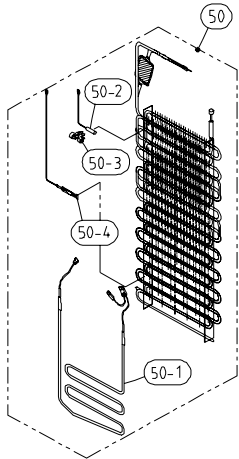
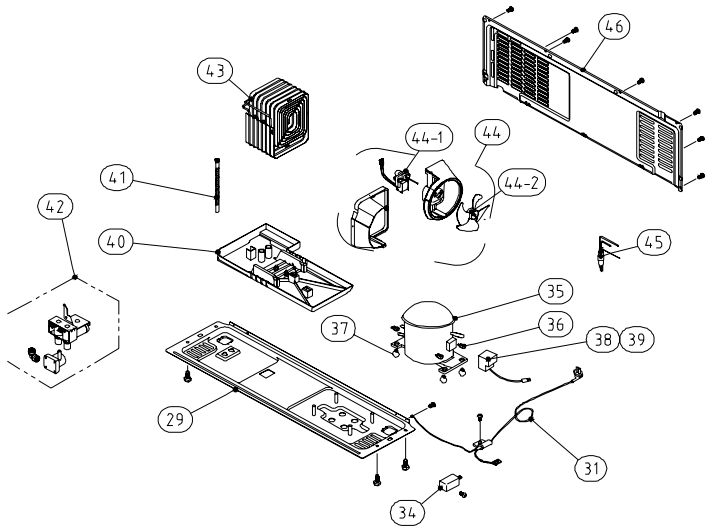

| NO | PART-CODE | PART NAME | SPEC. | Q'ty | | | |
|------|------------|--------------------|-------------------|------|------|---------|---------|
| | | | | 201E | 20BE | 20D(E)E | 20F(G)E |
| 29 | 3010340400 | BASE COMP AS | FRU-5711 | 1 | 1 | 1 | 1 |
| 31 | Page 88 | CORD POWER AS | | 1 | 1 | 1 | 1 |
| 34 | Page 88 | CAPACITOR RUN | | 1 | 1 | 1 | 1 |
| 35 | Page 88 | COMPRESSOR | | 1 | 1 | 1 | 1 |
| 36 | 3016002500 | SPECIAL WASHER | SK-5, T0.8 | 3 | 3 | 3 | 3 |
| 37 | 3010101600 | ABSORBER COMP | NBR (R-134a) | 4 | 4 | 4 | 4 |
| | 3010101480 | ABSORBER COMP AS | FRU-541D (R-600a) | | | | |
| 38 | Page 88 | SWITCH P RELAY AS | | 1 | 1 | 1 | 1 |
| 39 | Page 88 | COVER RELAY | | 1 | 1 | 1 | 1 |
| 40 | 3011181300 | CASE VAPORI AS | PP | 1 | 1 | 1 | 1 |
| 41 | 3013201710 | HOSE DRN B | PE FRB-5350NT | 1 | 1 | 1 | 1 |
| 42 | 3015402800 | VALVE WATER AS | 110~127V 60Hz | x | x | 1 | 1 |
| | 3015402300 | | 220~240V 50,60Hz | | | | |
| 43 | 3014461510 | PIPE WICON AS | TSW OD4.76XT0.7 | 1 | 1 | 1 | 1 |
| 44 | 3018500500 | M/BELL AS | FRU-5711 | 1 | 1 | 1 | 1 |
| 44-1 | 3015916100 | MOTOR C FAN AS | DC-2213DWCA-3 | 1 | 1 | 1 | 1 |
| 44-2 | 3011834700 | FAN | ABS OD3.17XD150 | 1 | 1 | 1 | 1 |
| 45 | 3016808100 | DRYER AS | C1220T | 1 | 1 | 1 | 1 |
| 46 | 3011497000 | COVER MACH ROOM AS | SBHG T0.35 | 1 | 1 | 1 | 1 |
| 50 | 3017053500 | EVA AS | FRU-5711 | 1 | 1 | 1 | 1 |
| 50-1 | 3012818300 | HEATER SHEATH AS | AC220V/ 192W | 1 | 1 | 1 | 1 |
| | 3012818400 | | AC115V/ 192W | | | | |
| 50-2 | 3014806900 | SENSOR D AS | PBN-43 | 1 | 1 | 1 | 1 |
| 50-3 | 3012023600 | FIXTURE D SENS | PP | 1 | 1 | 1 | 1 |
| 50-4 | 301720200 | FUSE TEMP AS | AC250V 10A 77C | 1 | 1 | 1 | 1 |

- Some parts can be chaged for improving their perfomance without notice.
 - Above parts number doesn't describe your own colour & printing. Please remind!

| Date | A mendment Note |
|------|-----------------|
| | |
| | |
| | |
| | |
| | |
| | |
| | |

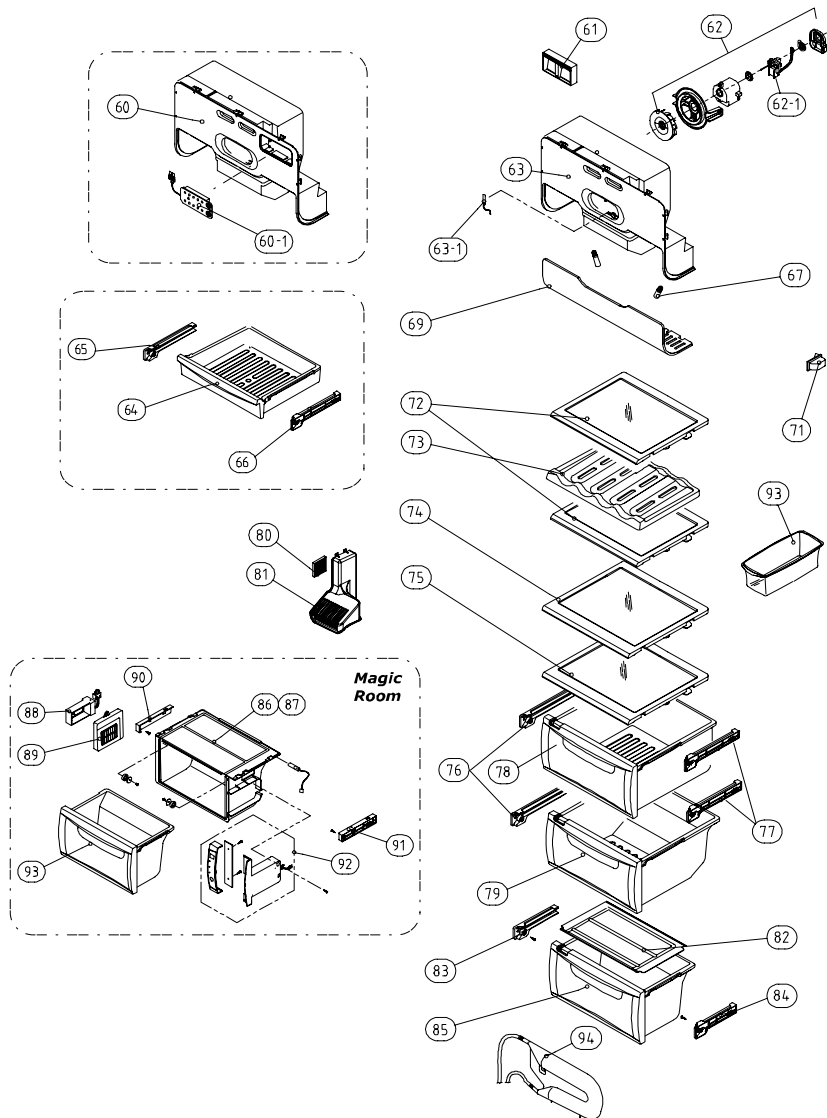

| NO | PART-CODE | PART NAME | SPEC. | Q'ty | | | | | | |
|------|------------|------------------------|------------------------|------|------|------|------|------|------|--------|
| | | | | 201E | 20BE | 20DE | 20EE | 20FE | 20GE | |
| 60 | 3011492800 | COVER DAMP AS | FRU-5711 | 1 | | | | | | |
| 60-1 | 3014235200 | PANEL CONTL *I AS | | 1 | | | | | | X |
| 61 | 3012205001 | FRAME CHECK VALV AS | FR-S580CG | 1 | 1 | 1 | 1 | 1 | 1 | 1 |
| 62 | 3012024200 | FIXTURE MOTR AS | | 1 | 1 | 1 | 1 | 1 | 1 | 1 |
| 62-1 | 3015916000 | MOTOR R FAN | D4612AAA20 | 1 | 1 | 1 | 1 | 1 | 1 | 1 |
| 63 | 3011495100 | COVER DAMP AS | FRU-541D | X | 1 | 1 | 1 | 1 | 1 | 1 |
| 63-1 | 3014807100 | SENSOR R AS | PBN-43B | 1 | 1 | 1 | 1 | 1 | 1 | 1 |
| 64 | 3011185710 | CASE CHILD | FRU-571 (NANO) | 1 | 1 | | | | | |
| 65 | 3012514511 | GUIDE CASE A *L AS | FR-S580EG(HIPS) | 1 | 1 | | | | | X |
| 66 | 3012514611 | GUIDE CASE A *R AS | FR-S580EG(HIPS) | 1 | 1 | | | | | |
| 67 | 3013602500 | LAMP F/R | AC 240V 25W | 2 | 2 | 2 | 2 | 2 | 2 | 2 |
| | 3013602800 | | AC 125V 25W | | | | | | | |
| 69 | 3015510800 | WINDOW R LAMP | MIPS | 1 | 1 | 1 | 1 | 1 | 1 | 1 |
| 71 | 3018124000 | SWITCH DR | SP201R-7DR (R-134a) | 1 | 1 | 1 | 1 | 1 | 1 | 1 |
| | 3018128600 | SWITCH DR | SPF101B-1D (R-600a) | | | | | | | |
| 72 | 3017842820 | SHELF INMOLDING R A AS | FRAME+PRINTED GLASS | 2 | 2 | 2 | 2 | 2 | 2 | 2 |
| 73 | 3017842500 | SHELF WINE | GPPS | | | | | | | OPTION |
| 74 | 3017843320 | SHELF INMOLDING R C AS | FRAME+PRINTED GLASS | 1 | 1 | | | | | X |
| 75 | 3017842920 | SHELF INMOLDING R B AS | FRAME+PRINTED GLASS | 1 | 1 | 1 | 1 | 1 | 1 | 1 |
| 76 | 3012514511 | GUIDE CASE A *L AS | FR-S580EG(HIPS) | 1 | 1 | 2 | 2 | 2 | 2 | 2 |
| 77 | 3012514611 | GUDIE CASE A *R AS | FR-S580EG(HIPS) | 1 | 1 | 2 | 2 | 2 | 2 | 2 |
| 78 | 3011109230 | CASE VEGETB A AS | CASE (NANO) +FRAME | | | | | | | |
| | 3011109200 | | CASE +FRAME | | X | | 1 | 1 | 1 | 1 |
| 79 | 3011114630 | CASE VEGETB B AS | CASE (NANO) +FRAME | 1 | 1 | 1 | 1 | 1 | 1 | 1 |
| | 3011114600 | | CASE +FRAME | | | | | | | |
| 80 | 3018701800 | DEO ANTI AS | W40XT5XL40 | 1 | 1 | 1 | 1 | 1 | 1 | 1 |
| 81 | 3011445900 | COVER RETURN DUCT | PP | 1 | 1 | 1 | 1 | 1 | 1 | 1 |
| 82 | 3011446700 | COVER VEGETB CASE B | GPPS | 1 | 1 | 1 | | | | 1 |
| 83 | 3012529711 | GUIDE CASE C *L AS | FRU-5711(HIPS) | 1 | 1 | 1 | | | | 1 |
| 84 | 3012529811 | GUIDE CASE C *R AS | FRU-5711(HIPS) | 1 | 1 | 1 | | X | | 1 |
| 85 | 3011114730 | CASE VEGETB C AS | CASE (NANO) +FRAME | 1 | 1 | 1 | | | | 1 |
| | 3011114700 | | CASE +FRAME | | | | | | | |
| 86 | 3011446800 | COVER CHANGE RM | GPPS | | | | | | | 1 |
| 87 | 3010548200 | BOX CHANGE RM | HIPS | | | | | | | 1 |
| 88 | 3016767100 | DAMPER AS | DU24-012 | | | | | | | 1 |
| 89 | 3011450901 | COVER DUCT CH RM AS | PP+SEAL | | | | | | | 1 |
| 90 | 3012529500 | GUDIE CHANGE RM *L | ABS | X | X | X | | | | 1 |
| 91 | 3012529600 | GUDIE CHANGE RM *R | ABS | | | | | | | 1 |
| 92 | 3010551000 | BOX CONTL CHANGE RM AS | | | | | | | | 1 |
| 93 | 3011115021 | CASE CHANGE RM AS | CASE (NANO) +FRAME+GAS | | | | | | | 1 |
| | 3011115001 | | FRU-541E | | | | | | | |
| 93 | 3011171310 | CASE EGG AS | CASE+VINYL | 1 | 1 | 1 | 1 | 1 | 1 | 1 |
| 94 | 3018201000 | TANK WATER AS | FRU-541D | X | X | 1 | 1 | 1 | 1 | 1 |

- Some parts can be chaged for improving their perfomance without notice.
 - Above parts number doesn't describe your own colour & printing. Please remind!

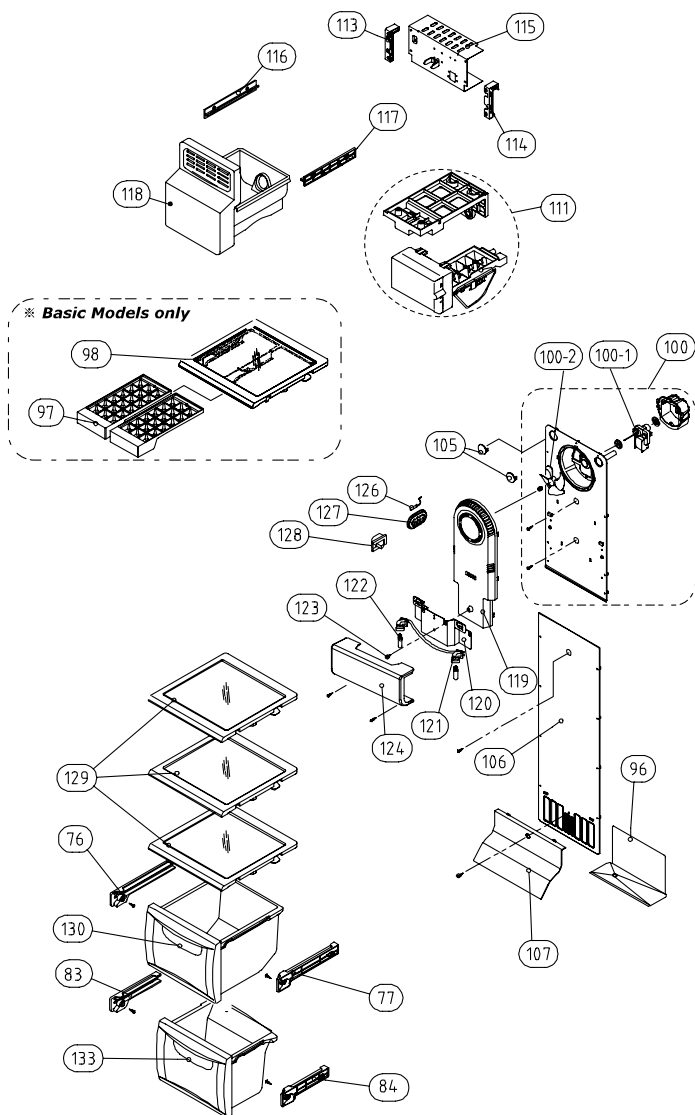

| NO | PART-CODE | PART NAME | SPEC. | Q'ty | | | |
|-------|------------|------------------------|-----------------------------|------|------|---------|---------|
| | | | | 20IE | 20BE | 20D(E)E | 20F(G)E |
| 76 | 3012514511 | GUIDE CASE A *L AS | FR-S580EG(HIPS) | 1 | 1 | 1 | 1 |
| 77 | 3012514611 | GUIDE CASE A *R AS | FR-S580EG(HIPS) | 1 | 1 | 1 | 1 |
| 83 | 3012529711 | GUIDE CASE C *L AS | FRU-571I(HIPS) | 1 | 1 | 1 | 1 |
| 84 | 3012529811 | GUIDE CASE C *R AS | FRU-571I(HIPS) | 1 | 1 | 1 | 1 |
| 96 | 3012529000 | GUIDE DRN | GA | 1 | 1 | 1 | 1 |
| 97 | 3011186300 | CASE ICE | PP | 2 | 2 | x | |
| 98 | 3017842710 | SHELF F ICE AS | FRAME+PRINTED GLASS+FIXTURE | 1 | 1 | | |
| 100 | 3018921710 | LOUVER F A AS | FRU-571I | 1 | 1 | 1 | 1 |
| 100-1 | 3015915900 | MOTOR F FAN | D4612AAA21 | 1 | 1 | 1 | 1 |
| 100-2 | 3011834500 | FAN | ABS OD3.17XD130 | 1 | 1 | 1 | 1 |
| 105 | 3010968600 | CAP F LOUVER B | HIPS | 2 | 2 | 2 | 2 |
| 106 | 3018921501 | LOUVER F B AS | HIPS | 1 | 1 | 1 | 1 |
| 107 | 3011443200 | COVER F RETURN | HIPS | 1 | 1 | 1 | 1 |
| 111 | 3012205810 | FRAME ICE MAKER AS | FRU-541D (R-134a) | x | x | 1 | 1 |
| | 3012205820 | | FRU-541D (R-600a) | | | 1 | 1 |
| 113 | 3012517800 | GUIDE G/MOTR BRKT *L | ABS | | | 1 | 1 |
| 114 | 3012517900 | GUIDE G/MOTR BRKT *R | ABS | | | 1 | 1 |
| 115 | 3010658220 | BRACKET GEARED MOTR AS | (MOLD/DY) 110~127V/60Hz | | | 1 | 1 |
| | 3010658150 | | (MOLD/DY) 220V/60Hz | | | 1 | 1 |
| | 3010658110 | | (MOLD/DY) 220~240V/50Hz | | | 1 | 1 |
| 116 | 3012520510 | GUIDE ICE CRUSHER *L | ABS | | | 1 | 1 |
| 117 | 3012517710 | GUIDE ICE CRUSHER *R | ABS | | | 1 | 1 |
| 118 | 3011115202 | CASE I/CRUSHER AS | FRU-541D | | | 1 | 1 |
| 119 | 3001401701 | COVER F FAN AS | FRU-571I | 1 | 1 | x | |
| | 3001401711 | COVER F FAN AS | FRU-541D | x | x | 1 | 1 |
| 120 | 3014531900 | PLATE F LAMP | SGCC T0.8 | 1 | 1 | 1 | 1 |
| 121 | 3017906600 | SOCKET F LAMP AS | FRU-571I | 1 | 1 | 1 | 1 |
| 122 | 3013602500 | LAMP F/R | AC 240V 25W(S) | 2 | 2 | 2 | 2 |
| | 3013602800 | | AC 125V 25W | | | | |
| 124 | 3015510700 | WINDOW F LAMP | MIPS | 1 | 1 | 1 | 1 |
| 126 | 3014807000 | SENSOR F AS | PT-38 | 1 | 1 | 1 | 1 |
| 127 | 3011442600 | COVER F SENS | ABS | 1 | 1 | 1 | 1 |
| 128 | 3018124010 | SWITCH DR | SP201R-7DR (R-134a) | 1 | 1 | 1 | 1 |
| | 3018128500 | | SPF101B-1D (R-600a) | | | | |
| 129 | 3017842600 | SHELF F AS | PRINTED GLASS | 3 | 3 | 3 | 3 |
| 130 | 3011114800 | CASE F A AS | CASE+FRAME | 1 | 1 | 1 | 1 |
| | 3011114830 | | CASE (NANO)+FRAME | | | | |
| 133 | 3011114900 | CASE F B AS | CASE+FRAME | 1 | 1 | 1 | 1 |
| | 3011114930 | | CASE (NANO)+FRAME | | | | |

- Some parts can be changed for improving their performance without notice.
 - Above parts number doesn't describe your own colour & printing. Please remind!

※ Basic Model

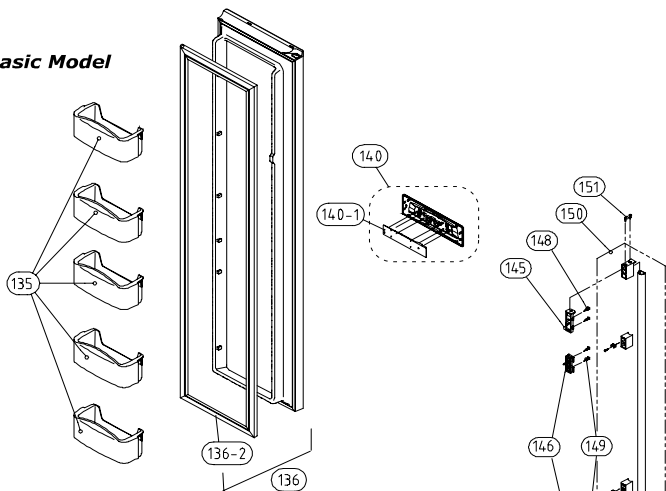

※ Dispenser Model

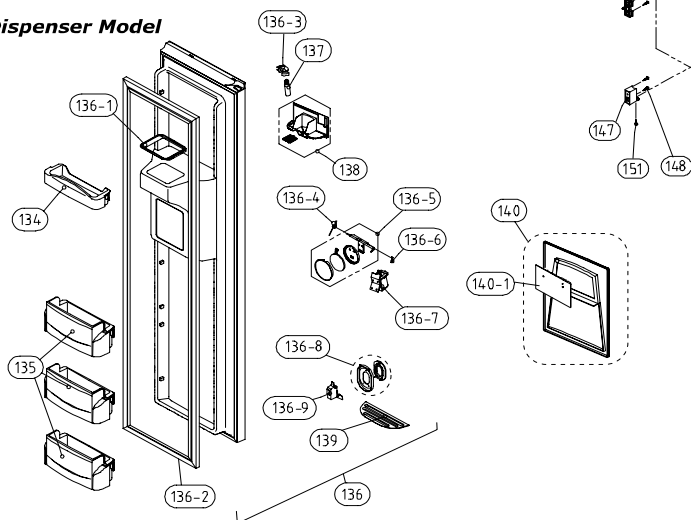

| NO | PART-CODE | PART NAME | SPEC. | Q'ty | | | |
|-------|------------|------------------------|---|------|------|---------|---------|
| | | | | 201E | 20BE | 20D(E)E | 20F(G)E |
| 134 | 3019026700 | POCKET F *T | HIPS | X | X | 1 | 1 |
| 135 | 3019026600 | POCKET F | HIPS | 5 | 5 | X | X |
| | 3019027401 | POCKET F AS | FRU-541D | X | X | 3 | 3 |
| 136 | 3000067610 | ASSY F DR | FRU-577I, SUH5E | 1 | X | X | X |
| | 3000067620 | | FRU-577I, ISG3E | X | 1 | X | X |
| | 3000067660 | | FRU-57BB, TSG5H | X | X | 1 | 1 |
| | 3000067670 | | FRU-57BB, MWH4L | X | X | 1 | 1 |
| | 3000067650 | | FRU-547F, SUH5E FRU-54B, TSH5L | X | X | 1 | 1 |
| 136-1 | 3010964601 | CAP ICE PATH FRAME | PP(FRS-551F) | X | X | 1 | 1 |
| 136-2 | 3012318810 | GASKET F DR AS | PVC+MAGNET | 1 | 1 | 1 | 1 |
| 136-3 | 3017903702 | SOCKET LAMP AS | 220V 15W | X | X | 1 | 1 |
| 136-4 | 3015102200 | SPRING ICE D LEVR | SUS | X | X | 1 | 1 |
| 136-5 | 3011495300 | COVER I/FLAP AS | FRU-541D | X | X | 1 | 1 |
| 136-6 | 3012019700 | FIXTURE I/SHUT LVR | FR-S650CD | X | X | 1 | 1 |
| 136-7 | 3015402100 | VALVE SOL DISP | 220V 60HZ | X | X | 1 | 1 |
| | 3015403110 | | 127V 60HZ | X | X | | |
| | 3015403200 | | AC 110-115V 60HZ | X | X | | |
| | 3015404100 | | 220-240V/50Hz | X | X | | |
| 136-8 | 3016304900 | BUTTON DISPNS AS | FRU-541D | X | X | 1 | 1 |
| 136-9 | 3018125800 | SWITCH MICRO | VP333A-2D | X | X | 1 | 1 |
| 137 | 3013600020 | LAMP AS | 240V/15W | X | X | 1 | 1 |
| | 3013600050 | | 110V/15W | X | X | | |
| 138 | 3010544000 | BOX DISPNS I/SHUT AS | FRU-541D | X | X | 1 | 1 |
| 139 | 3012406900 | GRILLE DISPNS | ABS | X | X | 1 | 1 |
| 140 | 3001401040 | COVER F PCB AS | EXPORT(FRU-579B/H) | X | 1 | X | X |
| | 3011494700 | COVER DISPNS BOX AS | FRU-541D | X | X | 1 | 1 |
| 140-1 | 30143E1110 | PCB FRONT AS | FR-S570ERB | X | 1 | X | X |
| | 30143D5160 | | FRU-541F | X | X | 1 | 1 |
| 145 | 3012027200 | FIXTURE HNDL SUPORT *T | HIPS | | | 1 | |
| 146 | 3012018700 | FIXTURE HNDL SUPORT *M | HIPS | | | 2 | |
| 147 | 3015311500 | SUPPORTER HNDL *U | ABS+SPRAY | | | 1 | |
| 148 | 7002401011 | SCREW MACHINE | TRS 4X10 MFZN | | | 4 | |
| 149 | 3016040100 | SPECIAL SCREW HNDL | M5X20 | | | 4 | |
| 150 | 3012645300 | HANDLE BAR AS | FRU-547F/SPRAY | | | 1 | |
| 151 | 3016040200 | SPECIAL SCREW FRAME | 4X14, S18C | | | 2 | |

- Some parts can be chaged for improving their performace without notice.
- Above parts number doesn't describe your own colour & printing. Please remind!

| Date | A mendment Note |
|------|-----------------|
| | |
| | |

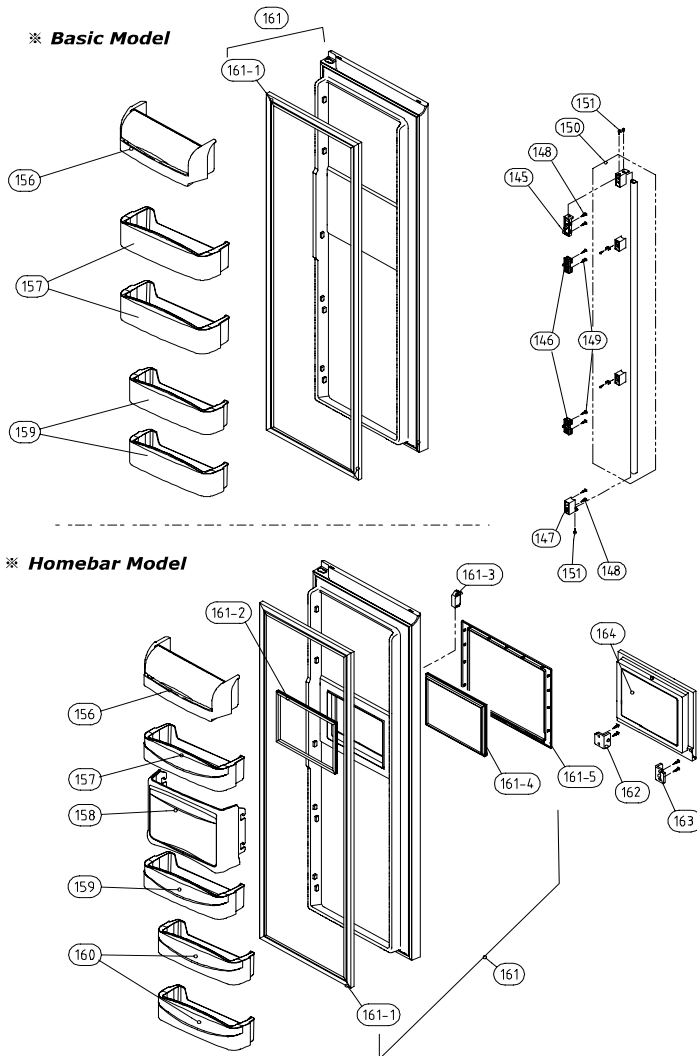

| NO | PART-CODE | PART NAME | SPEC. | Q'ty | | | | | |
|-------|------------|------------------------|-----------------|----------|---------|---------|---|---|---|
| | | | | 20I/E/BE | 20D(E)E | 20F(G)E | | | |
| 145 | 3012027200 | FIXTURE HNDL SUPORT *T | HIPS | | 1 | | | | |
| 146 | 3012018700 | FIXTURE HNDL SUPORT *M | HIPS | | 2 | | | | |
| 147 | 3015311500 | SUPPORTER HNDL *U | ABS+SPRAY | | 1 | | | | |
| 148 | 7002401011 | SCREW MACHINE | TRS 4X10 MFZN | | 4 | | | | |
| 149 | 3016040100 | SPECIAL SCREW HNDL | M5X20 | | 4 | | | | |
| 150 | 3012645300 | HANDLE BAR AS | FRU-547F/SPRAY | | 1 | | | | |
| 151 | 3016040200 | SPECIAL SCREW FRAME | 4X14, S18C | | 2 | | | | |
| 156 | 3019027500 | POCKET DAIRY AS | FRU-571I | 1 | 1 | 1 | | | |
| 157 | 3019026800 | POCKET R | HIPS | 2 | x | x | | | |
| | 3019027200 | POCKET R *M AS | FRU-541D | x | 2 | 1 | | | |
| 158 | 3011187000 | CASE H/BAR AS | FRU-541F | x | x | 1 | | | |
| 159 | 3019027700 | POCKET R H/BAR AS | FRU-541F | x | x | 1 | | | |
| 160 | 3019026900 | POCKET R *S | HIPS | 2 | x | x | | | |
| | 3019027300 | POCKET R *S AS | FRU-541D | x | 2 | 2 | | | |
| 161 | 3000067710 | ASSY R DR | FRU-577I, SUH5E | 1 | 1 | x | | | |
| | 3000067720 | | FRU-577I, ISG3E | | | | | | |
| | 3000067770 | | FRU-577B, TSG5H | | | | | | |
| | 3000067780 | | FRU-57B, MWH4L | | | | | | |
| | 3000067760 | | FRU-54BD, TSH5L | | | | | | |
| | 3000067700 | | FRU-547F, SUH5E | | | | x | x | 1 |
| | 3000067750 | | FRU-54BF, TSH5L | | | | | | |
| 161-1 | 3012318910 | GASKET R DR AS | PVC+MAGNET | 1 | 1 | 1 | | | |
| 161-2 | 3012319300 | GASKET H/BAR B AS | PVC | x | x | 1 | | | |
| 161-3 | 3018125600 | SWITCH H/BAR DR AS | SP101B-2D1(T) | x | x | 1 | | | |
| 161-4 | 3012319400 | GASKET H/BAR A AS | PVC | x | x | 1 | | | |
| 161-5 | 3011497200 | COVER FRAME H/BAR | ABS | x | x | 1 | | | |
| 162 | 3015204500 | STOPPER H/BAR DR *R | PO T4.0 | x | x | 1 | | | |
| 163 | 3015204400 | STOPPER H/BAR DR *L | PO T4.0 | x | x | 1 | | | |
| 164 | 3011767900 | DOOR H/BAR AS | FRU-541F, AL | x | x | 1 | | | |







- Some parts can be chaged for improving their performace without notice.
 - Above parts number doesn't describe your own colour & printing. Please remind!

| Date | A mendment Note |
|------|-----------------|
| | |
| | |
| | |
| | |
| | |
| | |
| | |

1. Electric Device

| Compressor | | Capacitor Run | | Realy Cover | | Switch P Relay AS | | Remark |
|---------------|------------|-------------------|------------|-------------|----------------|-------------------|------------|-----------------------|
| Specification | Part Code | Specification | Part Code | Part code | Specification | Specification | Part Code | |
| HPL30YG-5 | 395S130R50 | 400VAC/5 μ F | 3016401920 | 3811400503 | PP(SW5101SW) | 308NHB, S330 | 3018129810 | 220~240V/50Hz |
| MK183Q-L2U | 3956183D50 | 350VAC/5 μ F | 3016401170 | 3811402100 | DS3-3NORYL S/S | 265RHB, S330 | 3018129600 | 220~240V/50Hz |
| MK183C-L2U | 3956183D10 | 250VAC/12 μ F | 3016405000 | 3811402100 | DS3-3NORYL S/S | 445PHB, 4R7M | 3018129610 | 110~15V/60Hz |
| MK4A5Q-R1U | 3956145250 | 350VAC/5 μ F | 3016401170 | 3811402200 | S/S (R600A) | 265RHB, S330 | 3018129600 | 220~240V/50Hz(R-600a) |
| EGZ90CLC | 3956190M50 | 350VAC/5 μ F | 3016401170 | 3001409900 | EMBRACO | 213PFB, S220 | 3018129630 | 220~240V/50Hz(R-600a) |

2. Power Cord

| Shape | Description | Part Code | Shape | Description | Part Code |
|---|-----------------------|------------|--|--------------------|------------|
|  | CP-2PIN | 3011304100 |  | KP-550 (China) | 3011301070 |
| | CP-2PIN(Ferrite) | 3011346701 | | KP-550 (Australia) | 3011301080 |
|  | KP-30 | 3011348300 | | MP5004 (SINGAPORE) | 3011302870 |
|  | KP-211 | |  | ISRAEL | 3011301280 |
|  | SA16A (South Africa) | 3011302170 | | | |
|  | BS-1363 (U.K) | 3011347300 | | | |