

(ART NO. WR18197 C6)

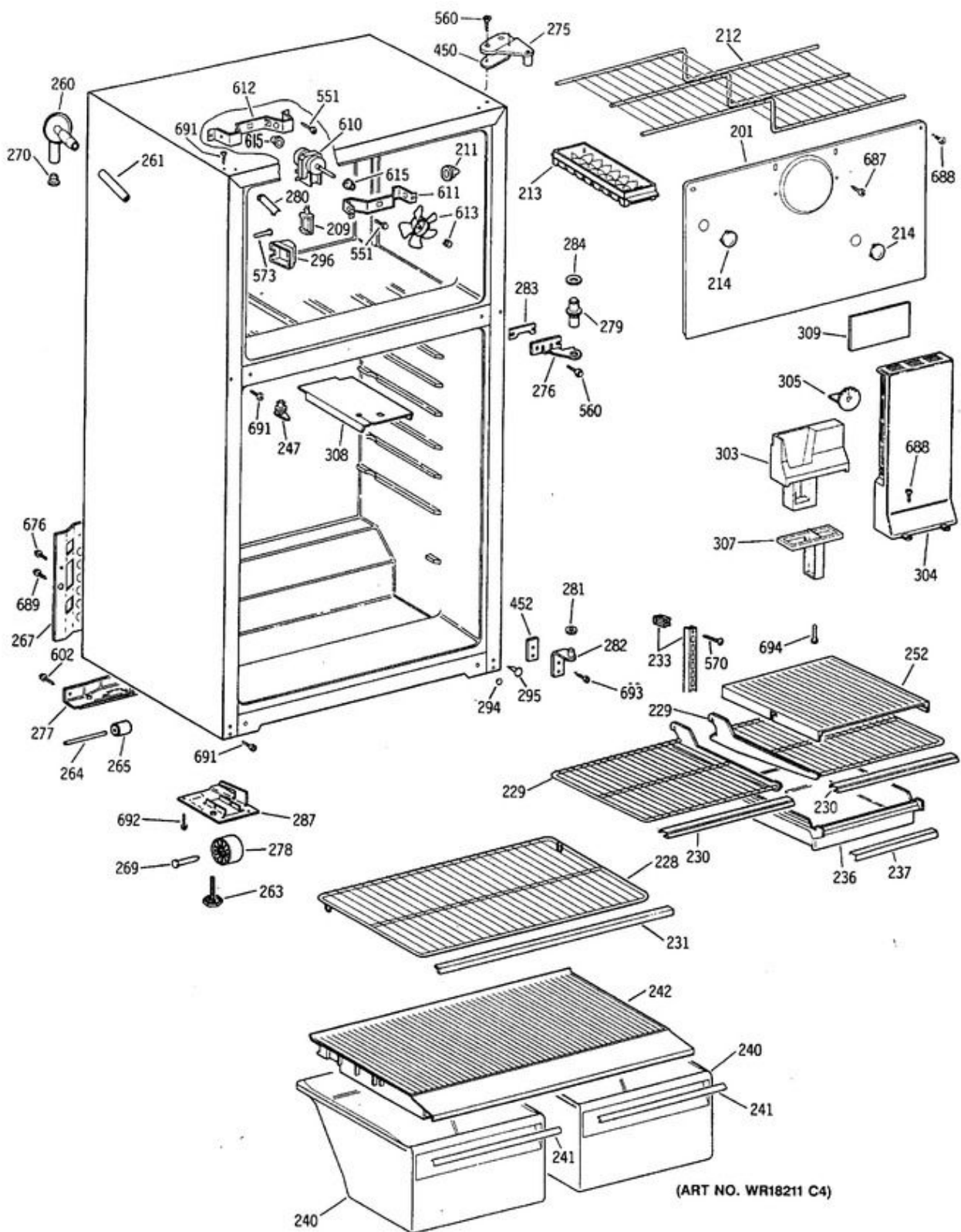

(ART NO. WR18211 C4)

