

(ART NO. WR18504 C5)

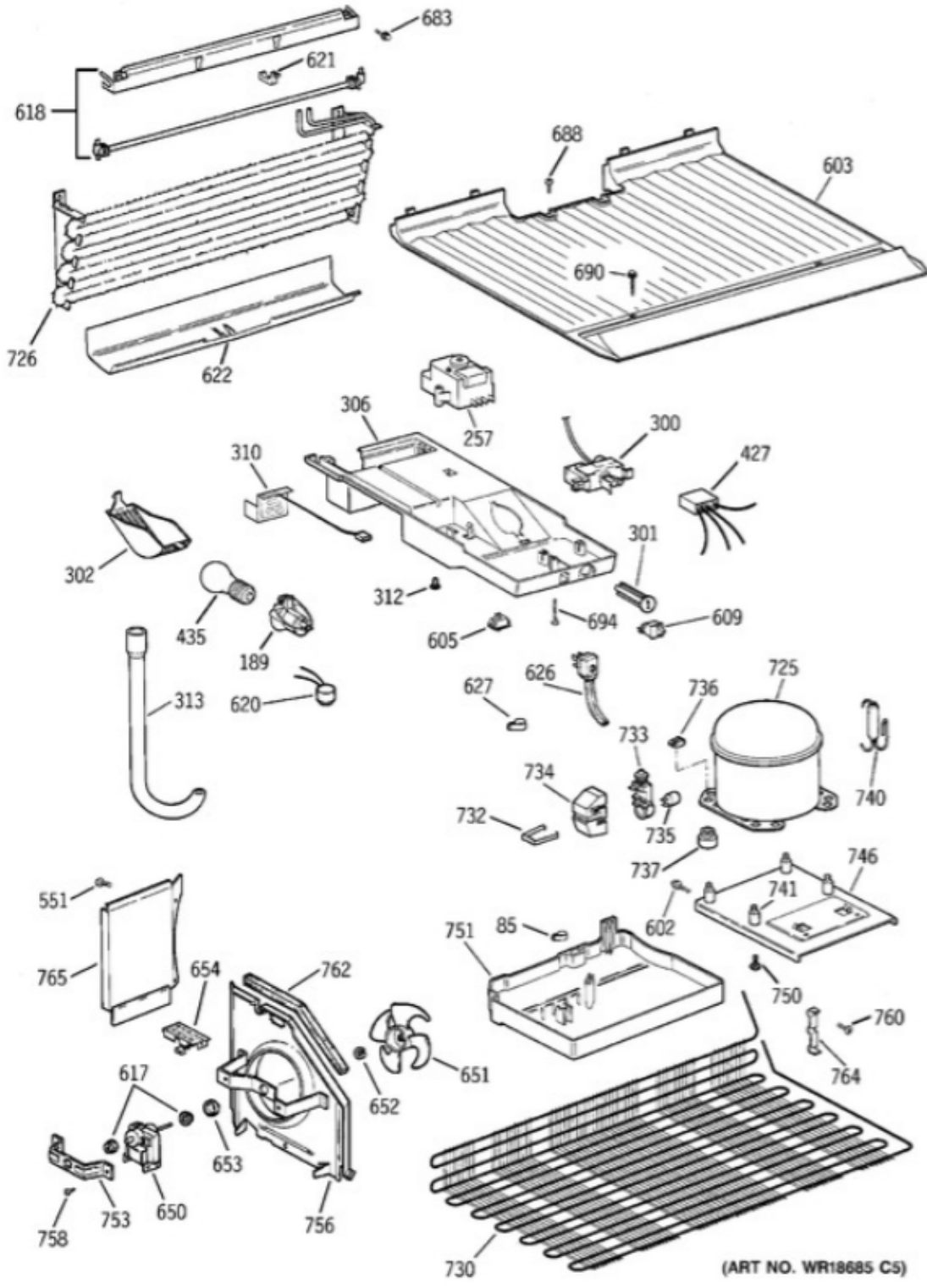

(ART NO. WR18685 C5)