

(ART NO. WR18383 C)

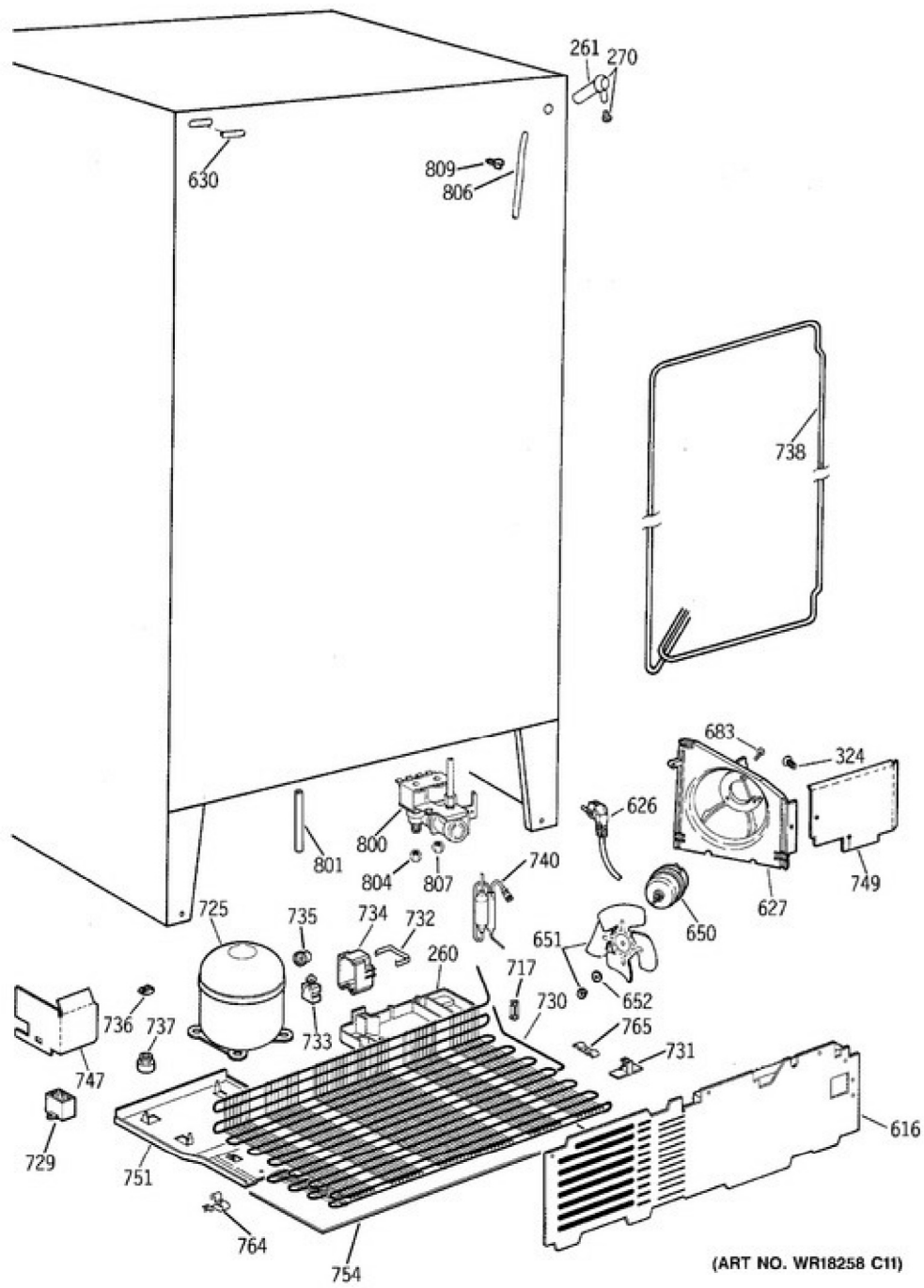

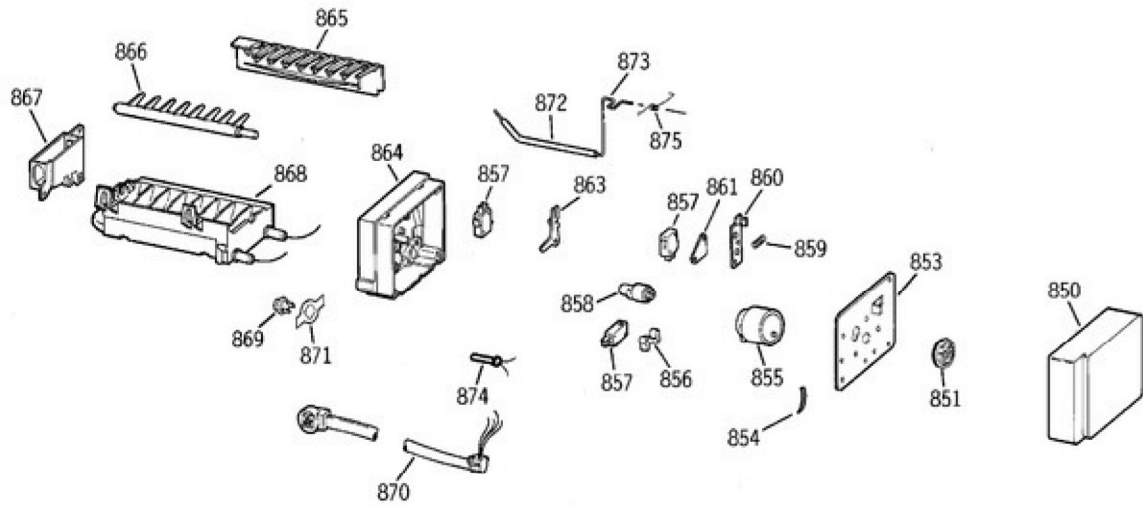

(ART NO. WR18599 C6)