

GRAPHIC EQUALIZER G-EQ300 SERVICE MANUAL

KENWOOD

© 1997-9/B51-5354-00 (K/K) 3669

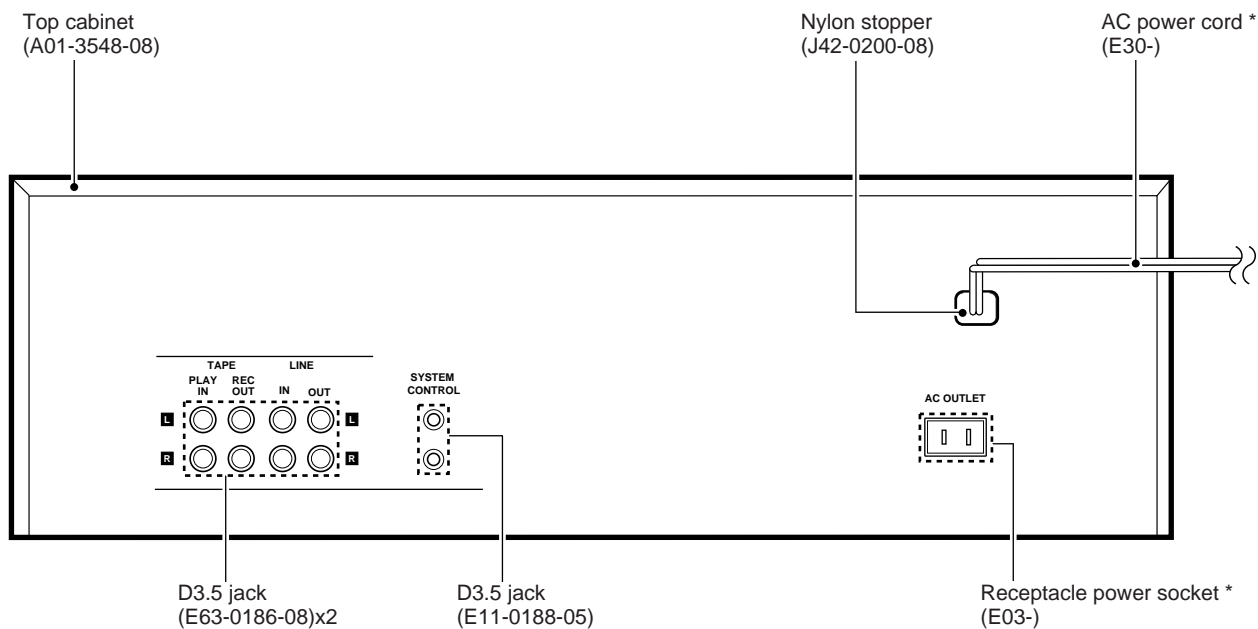
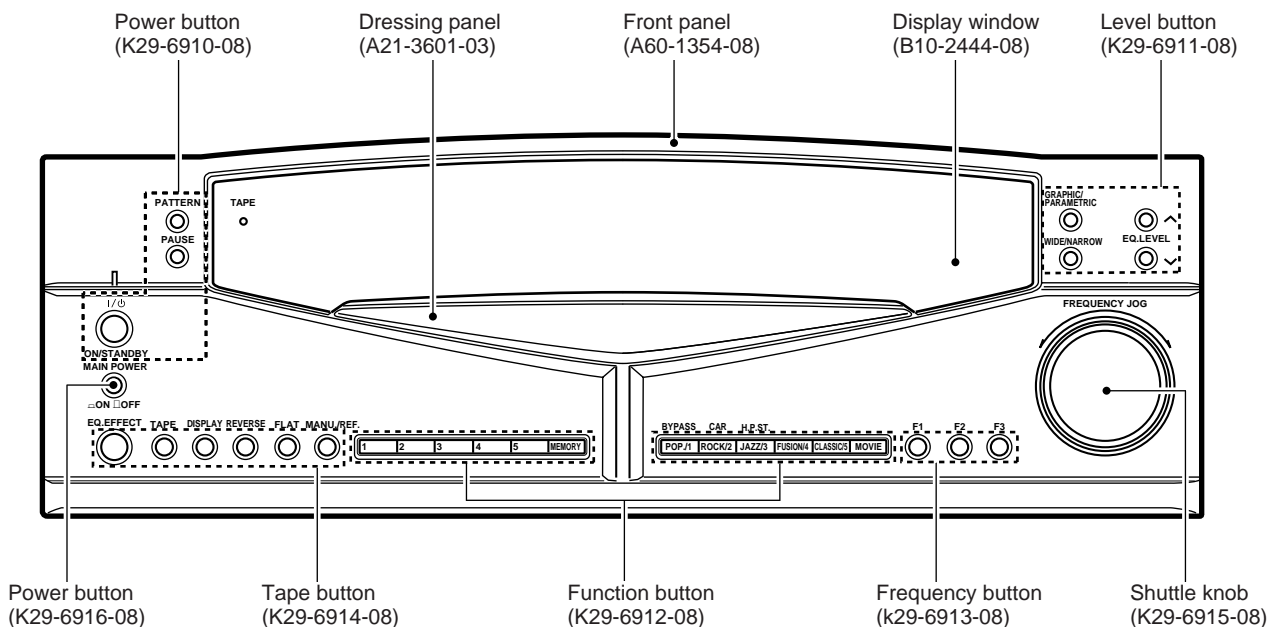

* Refer to parts list on page 16.

G-EQ300

CONTENTS / ACCESSORIES

Contents

CONTENTS / ACCESSORIES	2	EXPLODED VIEW	15
CONTROLS	3	PARTS LIST	16
PC BOARD	5	SPECIFICATIONS	Back cover
SCHEMATIC DIAGRAM	9		

Accessories

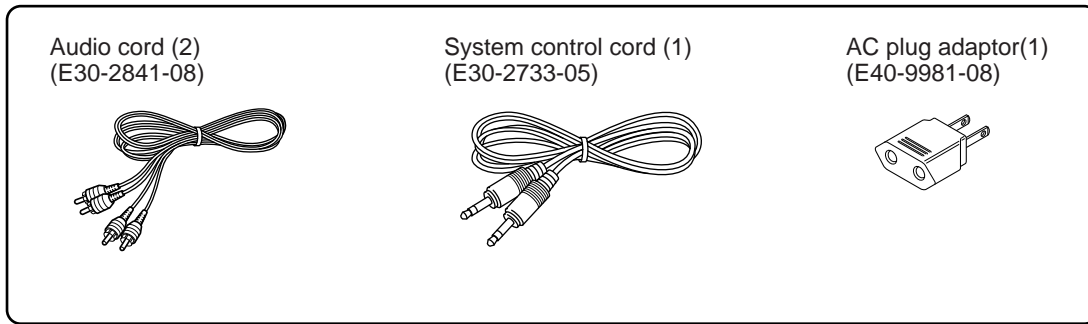

In case of difficulty

What appears to be a malfunction may not always be serious. If your unit should not perform as expected, consult the table below to see if the problem can be corrected before seeking help from your dealer or service representative.

Operation to reset

The microprocessor may fall into malfunction (impossibility to operate erroneous display, etc.) when the power cord is unplugged while power is ON or due to an external factor. In this case, execute the following procedure to reset the microprocessor and return it to normal condition.



While holding the MEMORY key depressed, press the MAIN POWER switch to on.

- Please note that resetting the microprocessor clears the contents stored in, it returns the microprocessor to the condition when it left the factory.

CONTROLS

Names and functions of parts

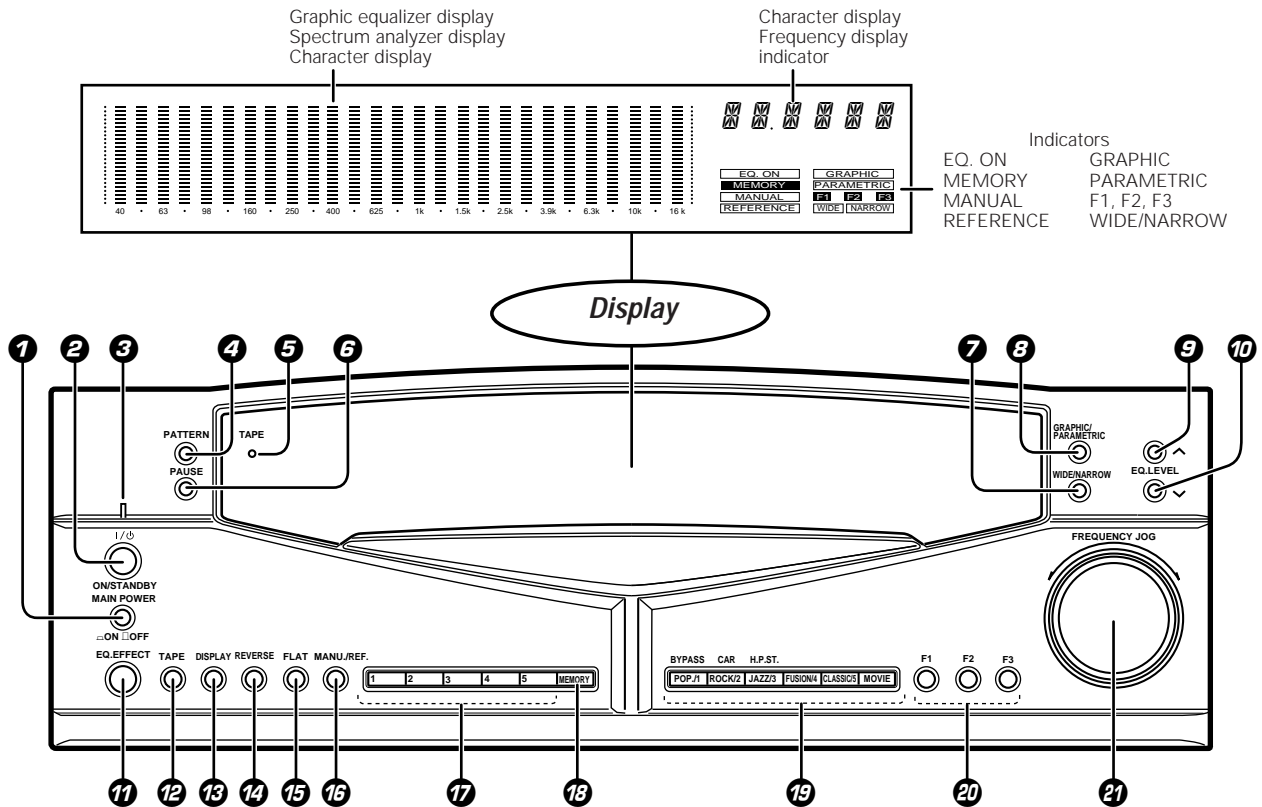

- 1 MAIN POWER key**
Switch the unit ON mode.
- 2 ON/STANDBY key**
Switch the unit between ON mode and STANDBY mode.
- 3 Standby indicator**
Lights up to indicate that a small amount of current flows in the unit.
- 4 PATTERN key**
Press to enter or quit the genre mode.
- 5 TAPE indicator**
Lights up when the TAPE key is pressed to ON.
- 6 PAUSE key**
Press to let an equalizer curve pause temporarily.
- 7 WIDE/NARROW key**
Each press of the key switches the curve slope alternately between WIDE and NARROW.
- 8 GRAPHIC/PARAMETRIC key**
GRAPHIC: Select this mode when adjusting an equalizer curve.
PARAMETRIC: Select this mode when creating an equalizer curve according to center frequencies.
- 9/10 EQ. LEVEL ^ (UP) / v (DOWN) keys**
Press the ^ (up) or v (down) key to increase or decrease the equalizer level.
- 11 EQ. EFFECT key**
Press to turn the equalizer mode ON and OFF.
- 12 TAPE key**
Use when playing back or recording a tape.
- 13 DISPLAY key**
Press to switch the display mode or to select the demonstration mode.
- 14 REVERSE key**
Press to reverse an equalizer curve.
- 15 FLAT key**
Press to make an equalizer curve flat.
- 16 MANU./REF. key**
Press to switch the manual and reference functions alternately.
- 17 Preset keys (1 to 5)**
Typical equalizer patterns have been preset under these keys so that you can select any one of them easily.
- 18 MEMORY key**
Press this key when registering a user-created equalizer pattern.
- 19 Genre keys**
Press in the genre mode to select the desired music genres and their equalizer patterns.
- 20 Frequency keys (F1, F2, F3)**
Each key can store a desired center frequency.
- 21 FREQUENCY JOG knob**
Rotate the control knob to adjust the frequency band (range).

STANDBY indicator

While standby mode is indicated, a small amount of power is supplied to the system to back up the memory. In this mode, the system can be turned ON by remote control.

G-EQ300

PARTS DESCRIPTIONS

CAPACITORS

CC 45 TH 1H 220 J
 1 2 3 4 5 6

- 1 = Type ... ceramic, electrolytic, etc.
- 2 = Shape ... round, square, ect.
- 3 = Temp. coefficient
- 4 = Voltage rating
- 5 = Value
- 6 = Tolerance

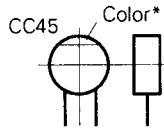

• Capacitor value

- 010 = 1pF
- 100 = 10pF
- 101 = 100pF
- 102 = 1000pF = 0.001μF
- 103 = 0.01μF

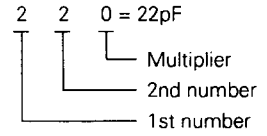

• Temperature coefficient

1st Word	C	L	P	R	S	T	U
Color*	Black	Red	Orange	Yellow	Green	Blue	Violet
ppm/°C	0	-80	-150	-220	-330	-470	-750

2nd Word	G	H	J	K	L
ppm/°C	±30	±60	±120	±250	±500

Example : CC45TH = -470 ± 60ppm/°C

• Tolerance (More than 10pF)

Code	C	D	G	J	K	M	X	Z	P	No code
(%)	±0.25	±0.5	±2	±5	±10	±20	+40 -20	+80 -20	+100 -0	More than 10μF -10 ~ +50 Less than 4.7μF -10 ~ +75

(Less than 10pF)

Code	B	C	D	F	G
(pF)	±0.1	±0.25	±0.5	±1	±2

• Voltage rating

2nd word \ 1st word	A	B	C	D	E	F	G	H	J	K	V
0	1.0	1.25	1.6	2.0	2.5	3.15	4.0	5.0	6.3	8.0	-
1	10	12.5	16	20	25	31.5	40	50	63	80	35
2	100	125	160	200	250	315	400	500	630	800	-
3	1000	1250	1600	2000	2500	3150	4000	5000	6300	8000	-

• Chip capacitors

(EX) C C 7 3 F S L 1 H 0 0 0 J
 1 2 3 4 5 6 7

(Chip) (CH, RH, UJ, SL)

(EX) C K 7 3 F F 1 H 0 0 0 Z
 1 2 3 4 5 6 7

(Chip) (B, F)

Refer to the table above.

- 1 = Type
- 2 = Shape
- 3 = Dimension
- 4 = Temp. coefficient
- 5 = Voltage rating
- 6 = Value
- 7 = Tolerance

Dimension (Chip capacitors)

Dimension code	L	W	T
Empty	5.6 ± 0.5	5.0 ± 0.5	Less than 2.0
A	4.5 ± 0.5	3.2 ± 0.4	Less than 2.0
B	4.5 ± 0.5	2.0 ± 0.3	Less than 2.0
C	4.5 ± 0.5	1.25 ± 0.2	Less than 1.25
D	3.2 ± 0.4	2.5 ± 0.3	Less than 1.5
E	3.2 ± 0.4	1.6 ± 0.2	Less than 1.25
F	2.0 ± 0.3	1.25 ± 0.2	Less than 1.25
G	1.6 ± 0.2	0.8 ± 0.2	Less than 1.0

RESISTORS

• Chip resistor (Carbon)

(EX) R K 7 3 E B 2 B 0 0 0 J
 1 2 3 4 5 6 7

(Chip) (B,F)

• Carbon resistor (Normal type)

(EX) R D 1 4 B B 2 C 0 0 0 J
 1 2 3 4 5 6 7

- 1 = Type
- 2 = Shape
- 3 = Dimension
- 4 = Temp. coefficient
- 5 = Rating wattage
- 6 = Value
- 7 = Tolerance

Dimension

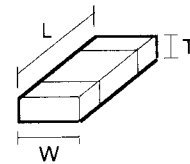

Dimension (Chip resistor)

Dimension code	L	W	T
E	3.2 ± 0.2	1.6 ± 0.2	1.0
F	2.0 ± 0.3	1.25 ± 0.2	1.0
G	1.6 ± 0.2	0.8 ± 0.2	0.5 ± 0.1

Rating wattage

Code	Wattage	Code	Wattage	Code	Wattage
1J	1/16W	2C	1/6W	3A	1W
2A	1/10W	2E	1/4W	3D	2W
2B	1/8W	2H	1/2W		

PC BOARD(Component side view)

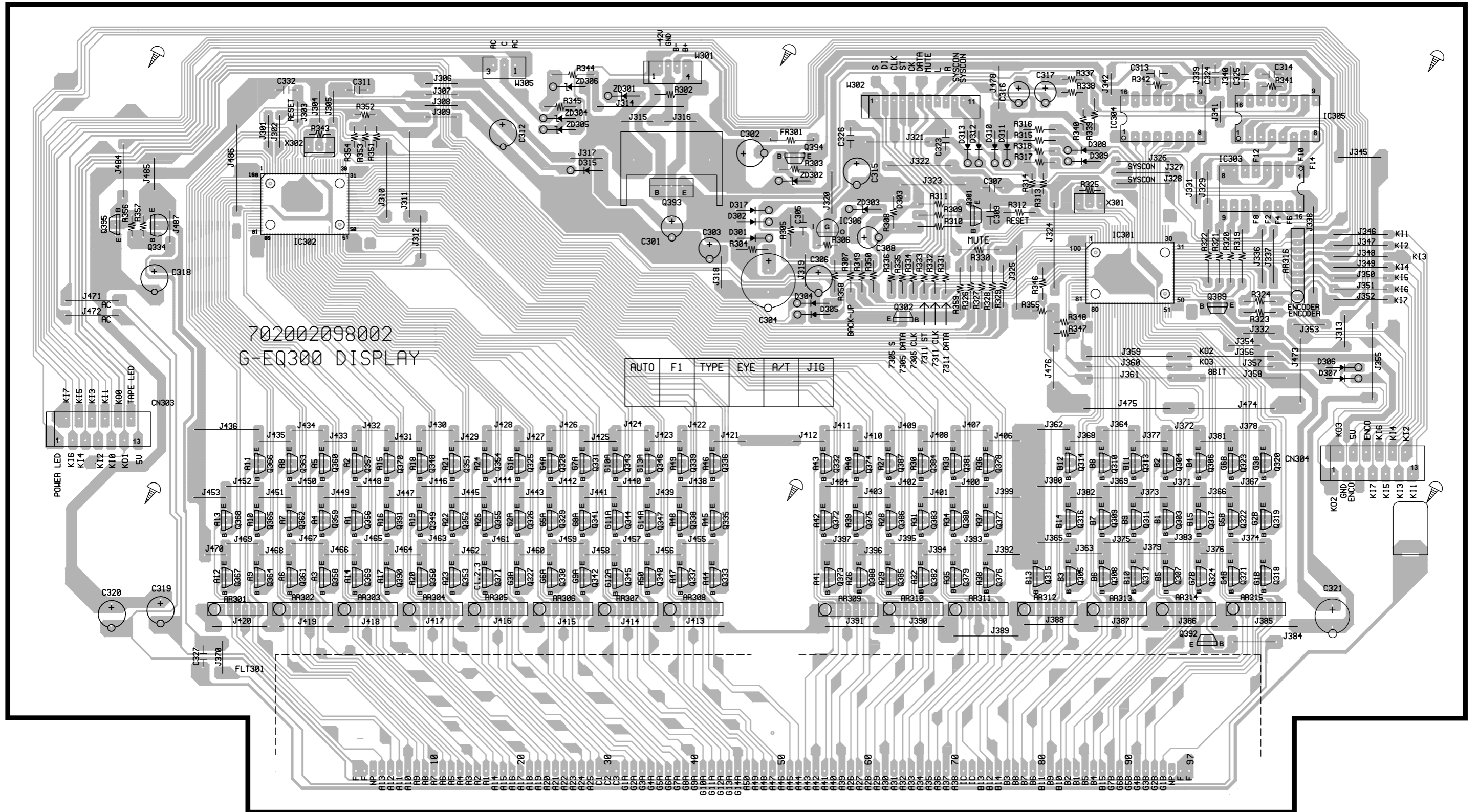

PC BOARD (Component side view)

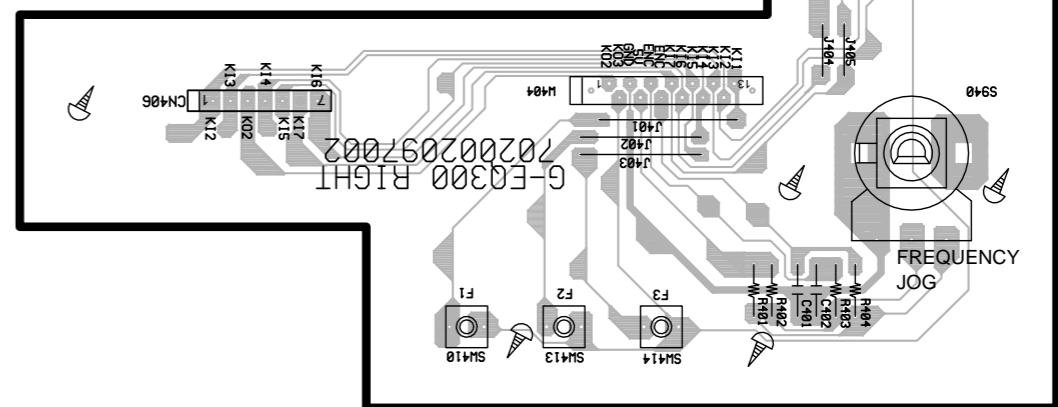
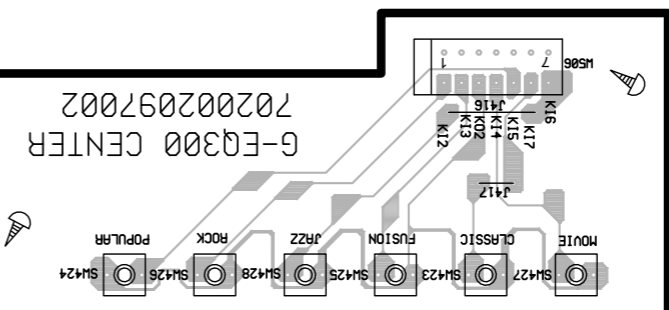
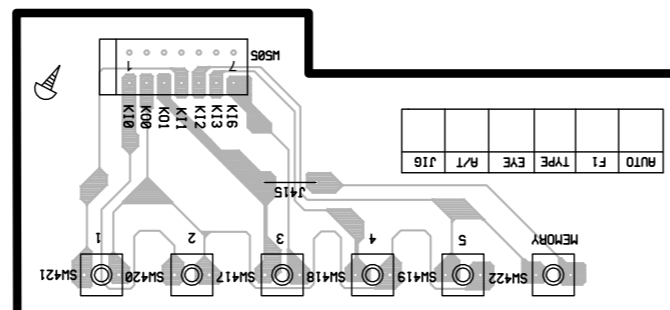
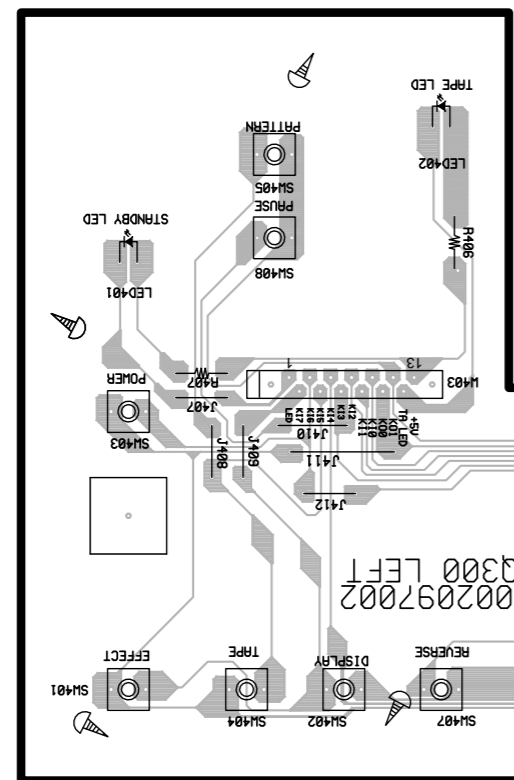
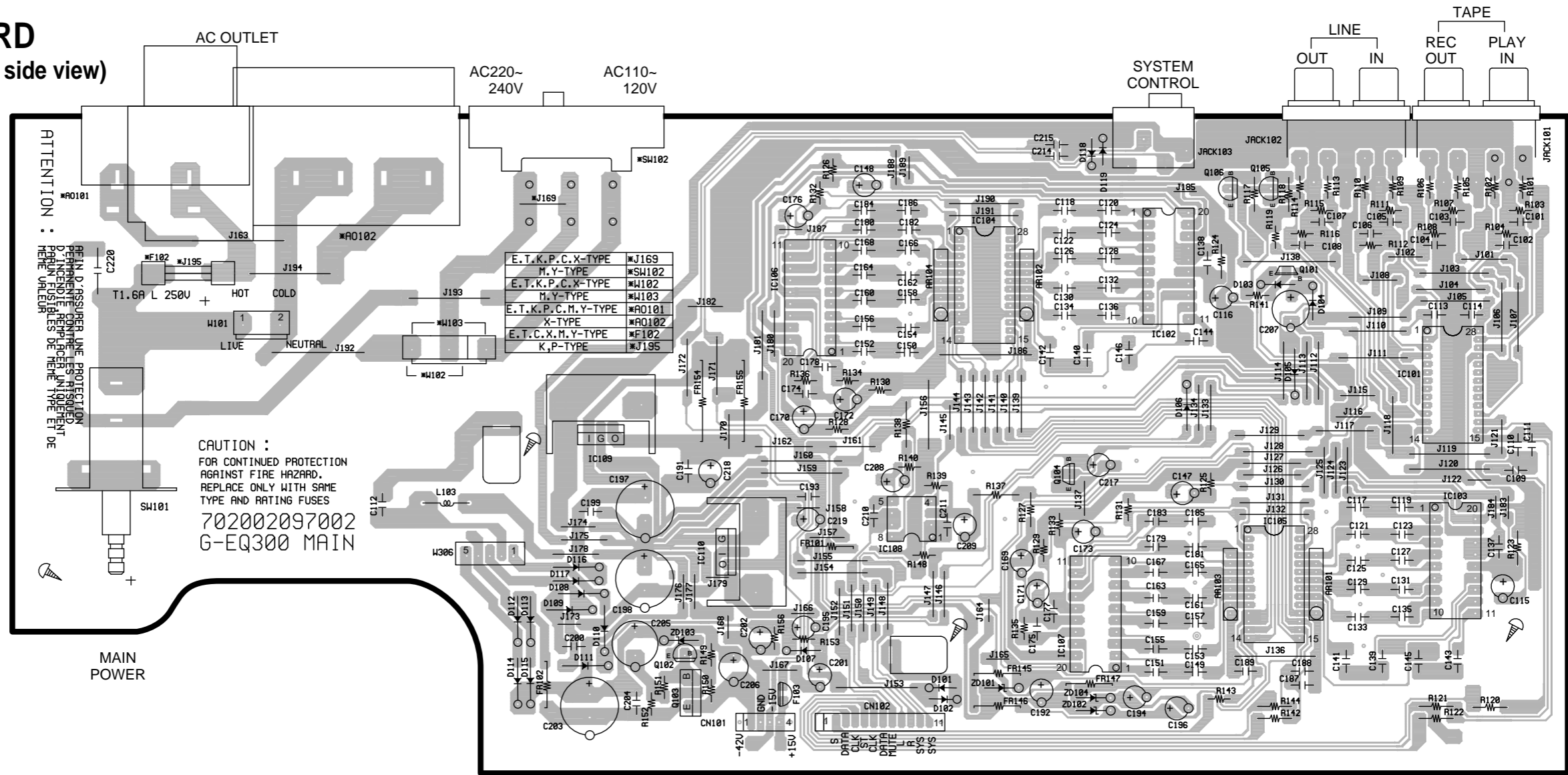

Refer to the schematic diagram for the value of resistors and capacitors.

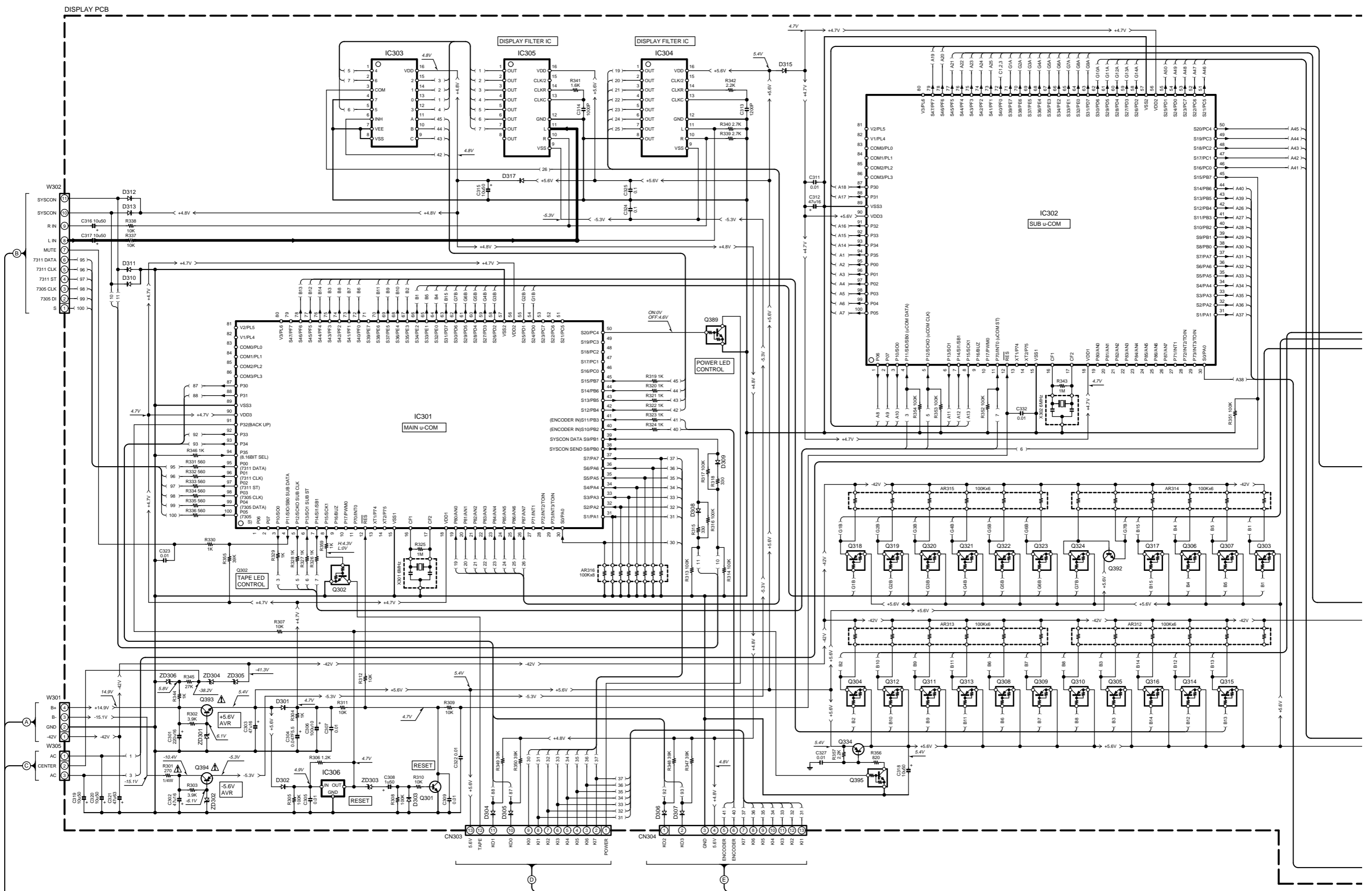

DISPLAY PCB

DISPLAY FILTER IC

DISPLAY FILTER IC

DISPLAY FILTER IC

IC301
MAIN u-COM

IC302
SUB u-COM

POWER LED CONTROL

TAPE LED CONTROL

RESET

RESET

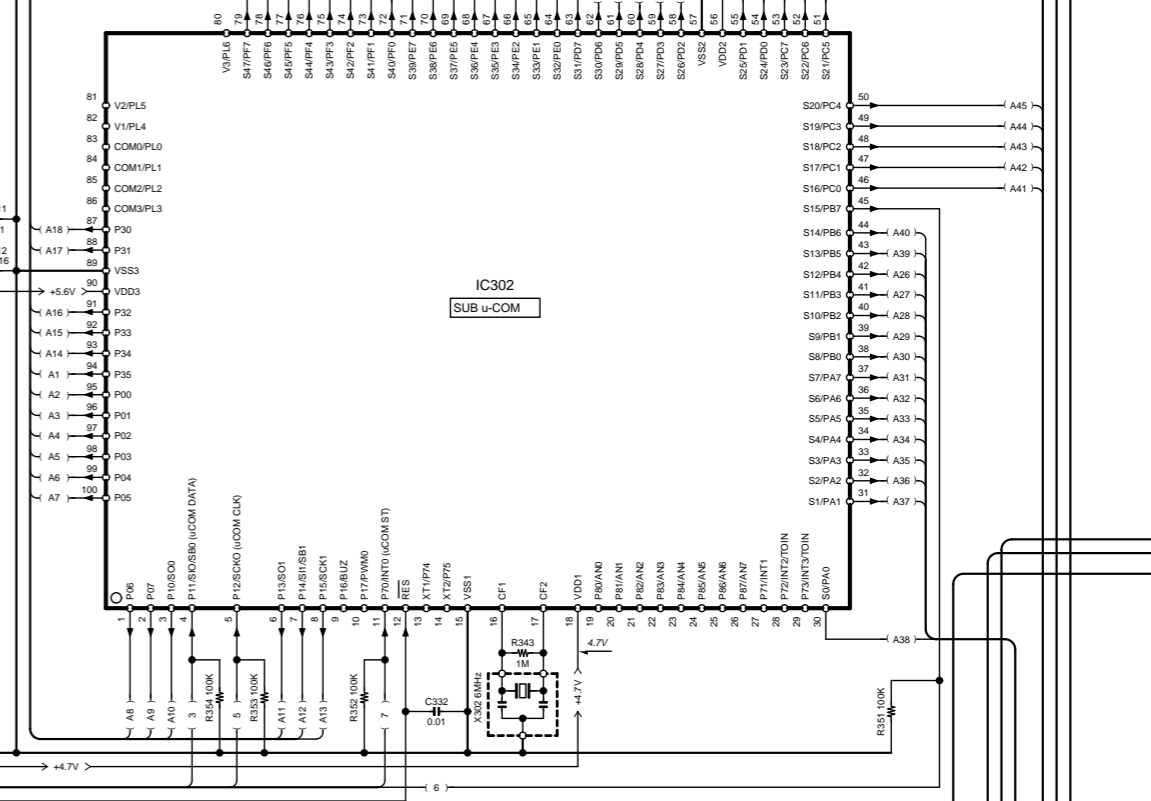
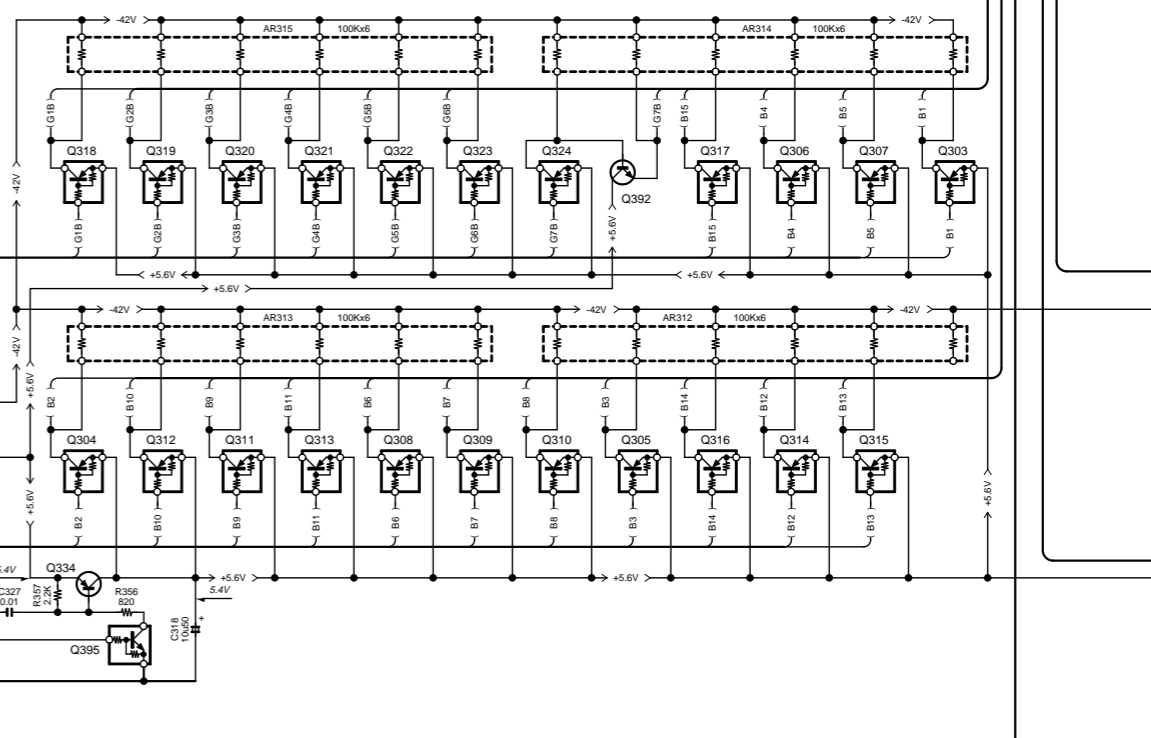
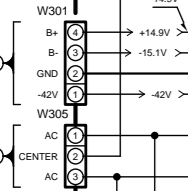
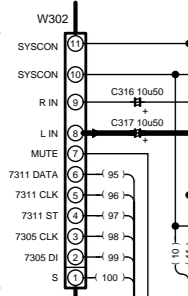

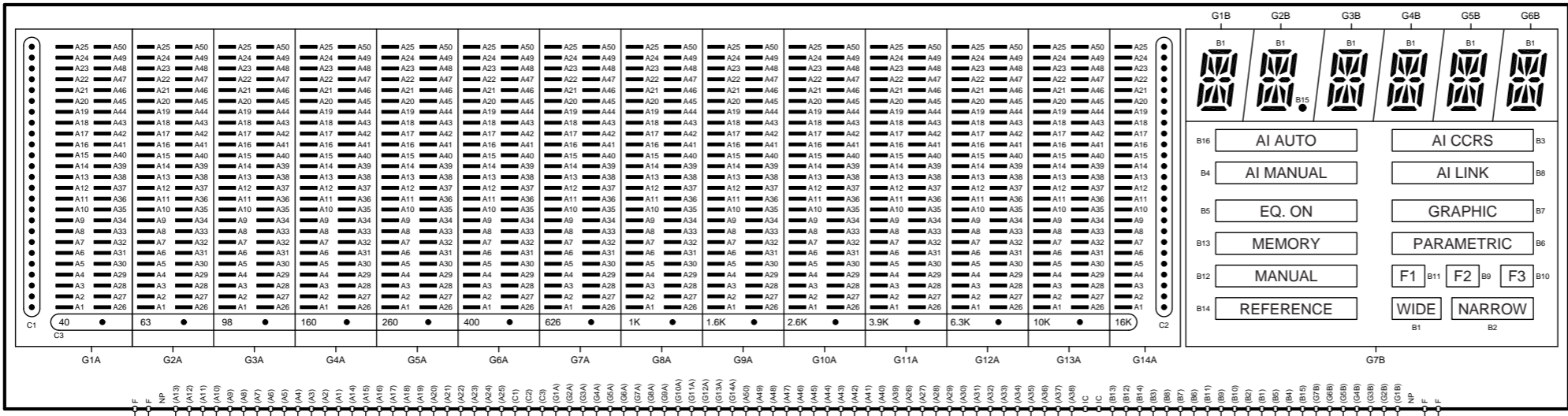

- IC301 : LC867224A-5D35
 - IC302 : LC867224A-5D36
 - IC303 : TC4051BP
 - IC304,305 : XR1091P
 - IC306 : KIA7039P
-
- Q301 : 2SC1740S
 - Q302,389,395 : DTC114ES
 - Q303-333,335-388,390,391 : DTA124ES
 - Q334 : KTA1271Y
 - Q392 : KTC3227Y
 - Q393 : KTD2058Y
 - Q394 : 2SA933S
-
- D301-313,315,317 : 1SS131
 - ZD301,302 : MTZJ6.2B
 - ZD303 : MTZJ2.7B
 - ZD304,305 : MTZJ4.7B
 - ZD306 : MTZJ5.6B
-
- FLT301 : FIP21BMW24

CAUTION: For continued safety, replace safety critical components only with manufacturer's recommended parts (refer to parts list). Δ indicates safety critical components. For continued protection against risk of fire, replace only with same type and rating fuse(s). To reduce the risk of electric shock, leakage-current or resistance measurements shall be carried out (exposed parts are acceptably insulated from the supply circuit) before the appliance is returned to the customer.

The DC voltage is an actual reading measured with a high impedance type voltmeter. The measurement value may vary depending on the measuring instruments used or on the product.

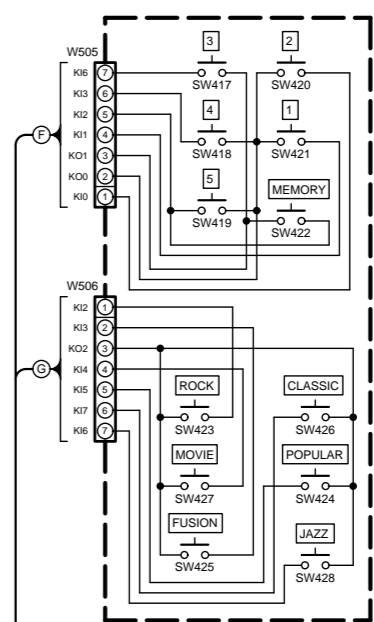
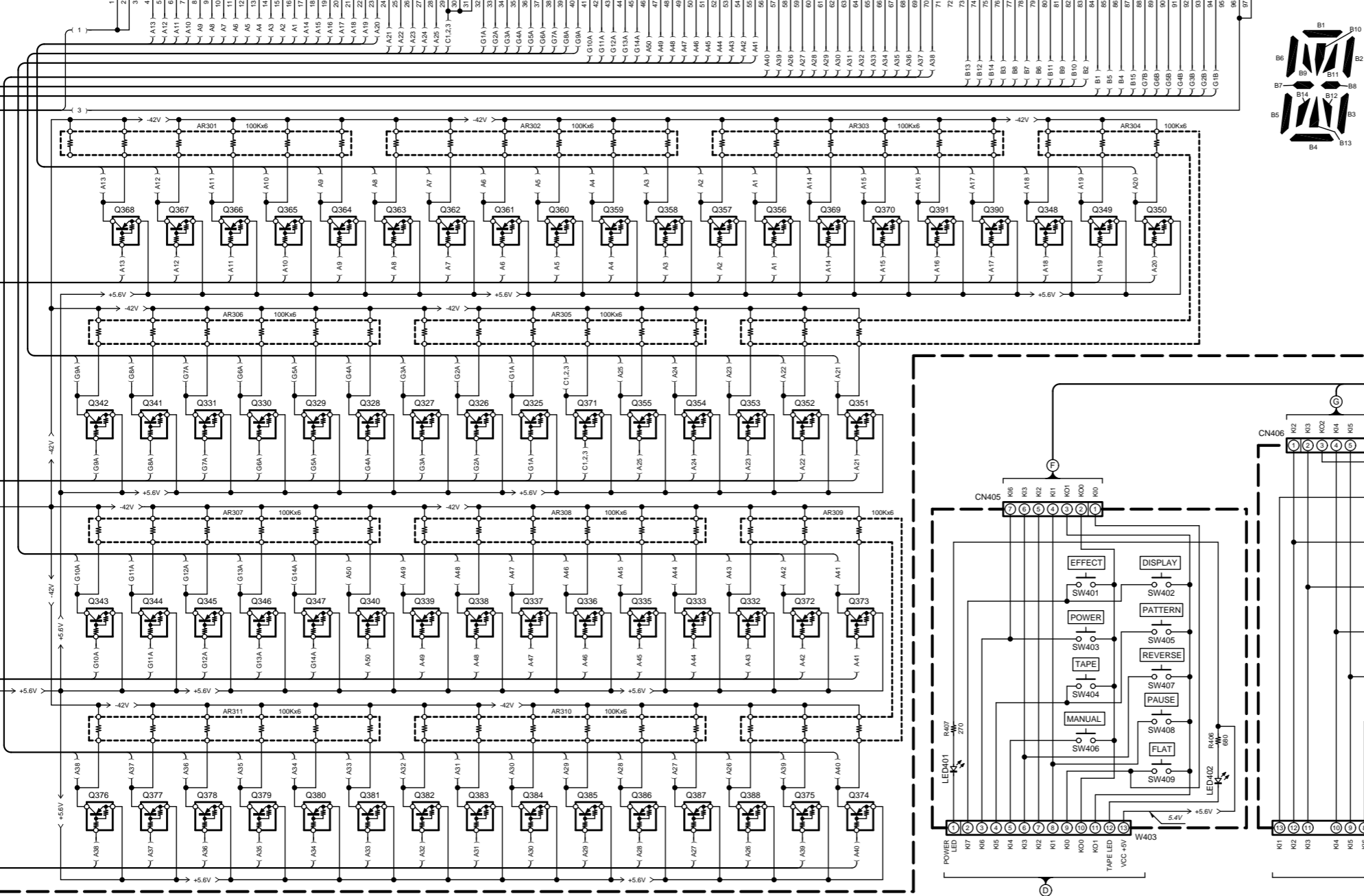
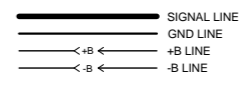

- DTA124ES
 - DTC114ES
 - DTC124ES
 - 2SA933S
 - 2SC1740S
-
- TC4051BP
-
- NJU7305L
-
- ICP-N15
-
- NJM4558DD
-
- M5229P
-
- NJU7311AL
-

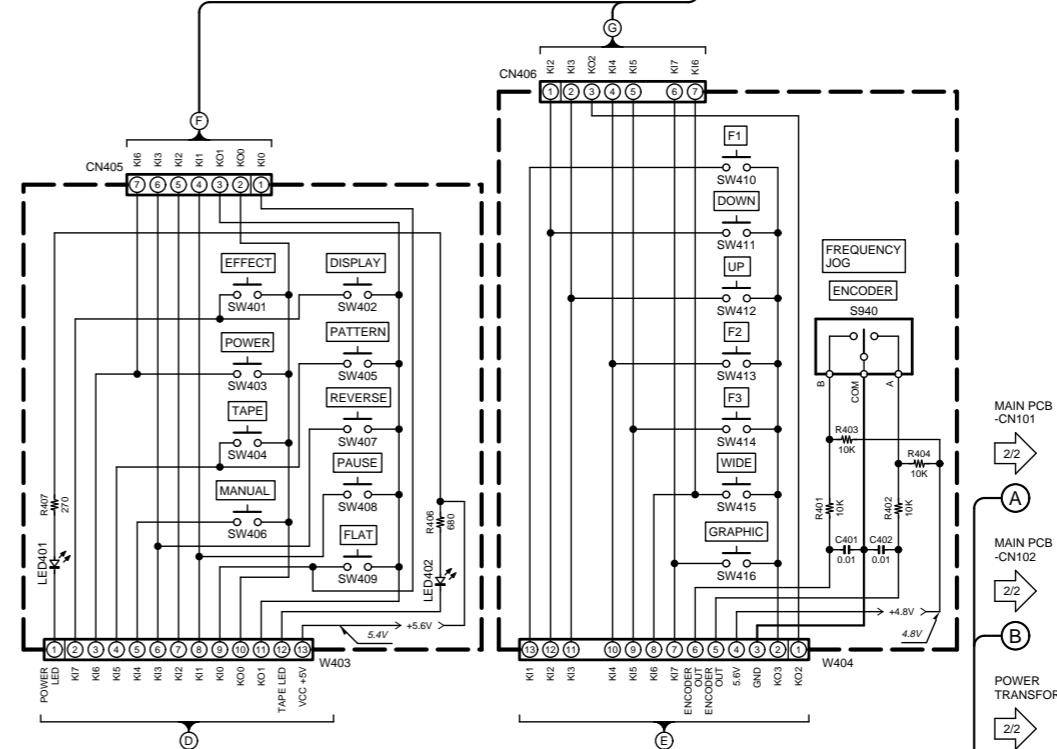

G-EQ300(M) (1/2)

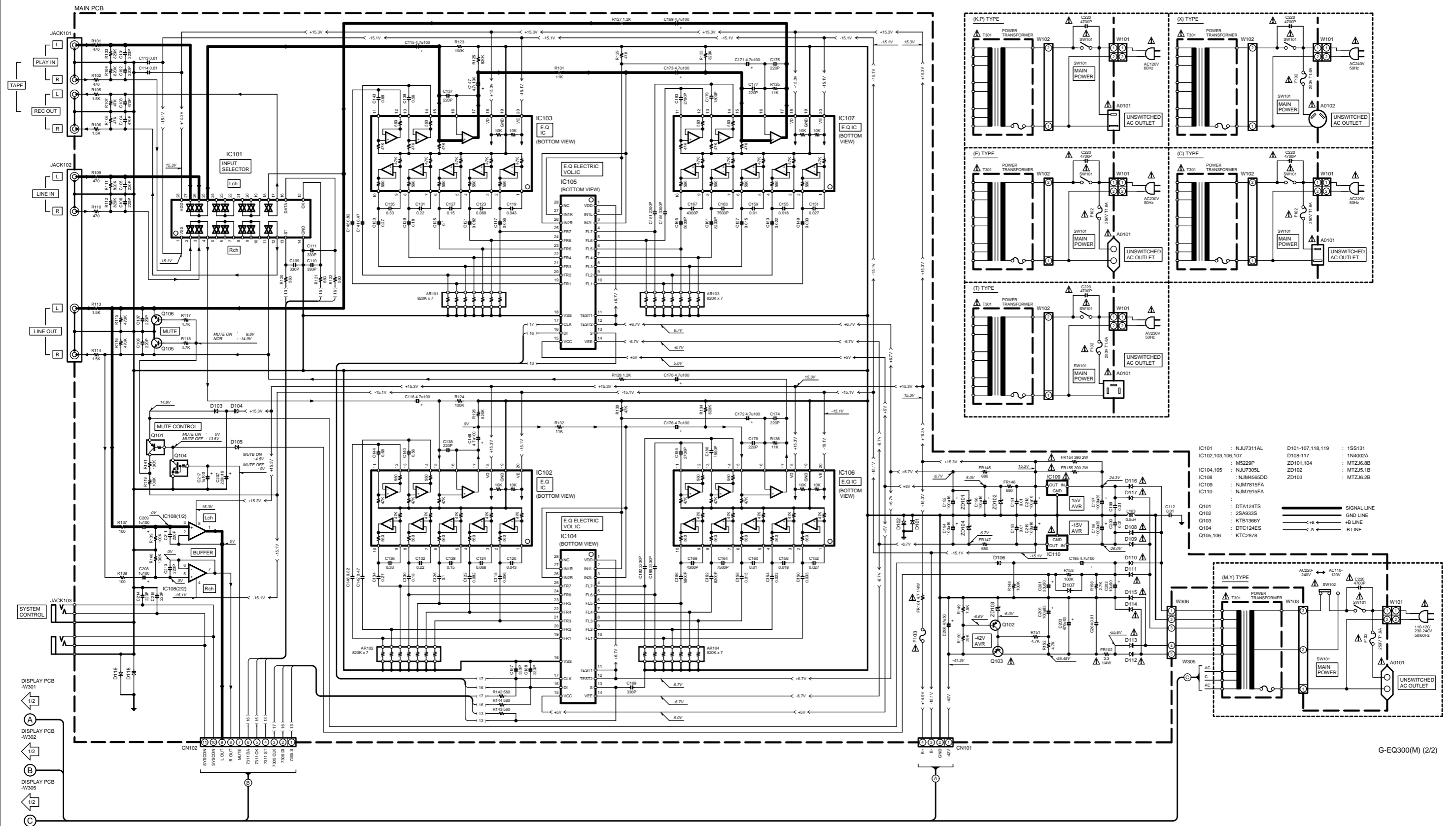

CAUTION: For continued safety, replace safety critical components only with manufacturer's recommended parts (refer to parts list). Δ indicates safety critical components. For continued protection against risk of fire, replace only with same type and rating fuse(s). To reduce the risk of electric shock, leakage-current or resistance measurements shall be carried out (exposed parts are acceptably insulated from the supply circuit) before the appliance is returned to the customer.

The DC voltage is an actual reading measured with a high impedance type voltmeter. The measurement value may vary depending on the measuring instruments used or on the product.

- | | | | |
|-------------------|-------------|------------------|------------|
| IC101 | : NJU7311AL | D101-107,118,119 | : 1SS131 |
| IC102,103,106,107 | : M5229P | D108-117 | : 1N4002A |
| IC104,105 | : NJU7305L | ZD101,104 | : MTZJ6.8B |
| IC108 | : NJM4565DD | ZD102 | : MTZJ5.1B |
| IC109 | : NJM7815FA | ZD103 | : MTZJ6.2B |
| IC110 | : NJM7915FA | | |

- | | |
|----------|------------|
| Q101 | : DTA124TS |
| Q102 | : 2SA933S |
| Q103 | : KTB1366Y |
| Q104 | : DTC124ES |
| Q105,106 | : KTC287B |

G-EQ300(M) (2/2)

G-EQ300
KENWOOD

G-EQ300

PARTS LIST

* New Parts
Parts without **Parts No.** are not supplied.
Les articles non mentionnés dans le **Parts No.** ne sont pas fournis.
Teile ohne **Parts No.** werden nicht geliefert.

①

Ref. No	Add-ress	New Parts	Parts No.	Description	Desti-nation	Re-marks
G-EQ300						
601	1A	*	A01-3548-08	CABINET, TOP		
602	2A	*	A21-3601-03	PANEL, DRESSING		
603	2A	*	A60-1354-08	PANEL AFTER PROCESS, FRONT		
605	2A	*	B10-2444-08	WINDOW AFTER PROCESS, DISPLAY		
606	2A	*	B19-1585-08	LENS, POWER		
-			B46-0096-53	WARRANTY CARD	X	
-			B46-0310-03	WARRANTY CARD	ET	
-			B46-0326-03	WARRANTY CARD	C	
-			B46-0330-03	WARRANTY CARD	KY	
-			B46-0336-03	WARRANTY CARD	P	
-		*	B60-3538-08	INSTRUCTION MANUAL(ENG)	KPYMCX	
-		*	B60-3538-08	INSTRUCTION MANUAL(ENG)	T	
-		*	B60-3539-08	INSTRUCTION MANUAL(FRN)	PE	
-		*	B60-3540-08	INSTRUCTION MANUAL(GRN)	E	
-		*	B60-3541-08	INSTRUCTION MANUAL(NTR)	E	
-		*	B60-3542-08	INSTRUCTION MANUAL(ITL)	E	
-		*	B60-3543-08	INSTRUCTION MANUAL(SPN)	EM	
-		*	B60-3544-08	INSTRUCTION MANUAL(CHN)	C	
-		*	B60-3545-08	INSTRUCTION MANUAL(TWN)	M	
610	1B	*	D21-1894-08	HOLDER, POWER		
615	1A		E30-2841-08	CORD, RCA		
616	1A		E30-2733-05	CORD, SYSTEM		
617	1C		E30-2799-08	CORD, AC	E	
617	1C		E30-2800-08	CORD, AC	KP	
617	1C		E30-2810-08	CORD, AC	X	
617	1C		E30-2840-08	CORD, AC	Y	
617	1C	*	E30-2875-08	CORD, AC	T	
617	1C	*	E30-2876-08	CORD, AC	C	
618	1A		E40-9981-08	ADAPTER, AC PLUG	M	
620	2A		H30-0100-04	TAPE		
-		*	H10-7434-08	CUSHION, SNOW		
-			H25-1575-08	POLY BAG, SET		
-			H25-1601-08	POLY BAG		
-		*	H50-2644-08	BOX, GIFT AFTER PROCESS	KPYXTE	
-		*	H50-2645-08	BOX, GIFT AFTER PROCESS	M	
-		*	H50-2646-08	BOX, GIFT AFTER PROCESS	C	
625	2C	*	J02-1401-08	FOOT ASSY		
626	2C		J19-5725-08	SUPPORTER, PCB		
627	1C		J42-0200-08	STOPPER, NYLON		
628	1C		J61-0101-05	STRAP, CABLE		
630	2A	*	K29-6910-08	BUTTON AFTER PROCESS, POWER		
631	2B	*	K29-6911-08	BUTTON AFTER PROCESS, LEVEL		
632	2A	*	K29-6912-08	BUTTON AFTER PROCESS, FUNCTION		
633	2B	*	K29-6913-08	BUTTON AFTER PROCESS, FREQUENCY		
634	2A	*	K29-6914-08	BUTTON AFTER PROCESS, TAPE		
635	2A	*	K29-6915-08	KNOB AFTER PROCESS, SHUTTLE		
636	1B	*	K29-6916-08	KNOB AFTER PROCESS, POWER		
ELECTRIC PARTS						
LD401			B30-2512-08	LED	P16-RD	
LD402		*	B30-2524-08	LED	P12-RD	

L : Scandinavia K : USA P : Canada R : Mexico C : China
Y : PX(Far East, Hawaii) T : Europe E : Europe G : Germany
Y : AAFES(Europe) X : Australia M : Other Areas

△ indicates safety critical components.

* New Parts
Parts without **Parts No.** are not supplied.
Les articles non mentionnés dans le **Parts No.** ne sont pas fournis.
Teile ohne **Parts No.** werden nicht geliefert.

②

Ref. No	Add-ress	New Parts	Parts No.	Description	Desti-nation	Re-marks
C101,102			CK45FB1H221K	CERAMIC	220PF	K
C103,104			CK45FB1H471K	CERAMIC	470PF	K
C105-108			CK45FB1H221K	CERAMIC	220PF	K
C109-111			CK45FB1H331K	CERAMIC	330PF	K
C112-114			CK45FB1H103K	CERAMIC	0.010UF	K
C115,116			CE04KW2A4R7M	ELECTRO	4.7UF	100WV
C117,118			CQ93FM1H563J	MYLAR	0.056UF	J
C119,120			CQ92FM1H433J	MYLAR	0.043UF	J
C121,122			CQ93FM1H823J	MYLAR	0.082UF	J
C123,124			CQ93FM1H683J	MYLAR	0.068UF	J
C125,126			CQ93FM1H104J	MYLAR	0.10UF	J
C127,128			CQ93FM1H154J	MYLAR	0.15UF	J
C129,130			CQ92FM1H184J	MYLAR	0.18UF	J
C131,132			CQ92FM1H224J	MYLAR	0.22UF	J
C133,134			CQ92FM1H274J	MYLAR	0.27UF	J
C135,136			CQ93FM1H334J	MYLAR	0.33UF	J
C137,138			CK45FB1H221K	CERAMIC	220PF	K
C139,140			CQ92FM1H564J	MYLAR	0.56UF	J
C141,142			CQ92FM1H474J	MYLAR	0.47UF	J
C143,144			CQ92FM1H684J	MYLAR	0.68UF	J
C145,146			CQ92FM1H824J	MYLAR	0.82UF	J
C147,148			CE04KW2A4R7M	ELECTRO	4.7UF	100WV
C149,150			CQ93FM1H333J	MYLAR	0.033UF	J
C151,152			CQ93FM1H273J	MYLAR	0.027UF	J
C153,154			CQ93FM1H223J	MYLAR	0.022UF	J
C155,156			CQ93FM1H183J	MYLAR	0.018UF	J
C157,158			CQ93FM1H153J	MYLAR	0.015UF	J
C159,160			CQ93FM1H103J	MYLAR	0.010UF	J
C161,162			CQ93FM1H822J	MYLAR	8200PF	J
C163,164			CQ92FM1H752J	MYLAR	7500PF	J
C165,166			CQ93FM1H562J	MYLAR	5600PF	J
C167,168			CQ92FM1H432J	MYLAR	4300PF	J
C169-173			CE04KW2A4R7M	ELECTRO	4.7UF	100WV
C174,175			CK45FB1H221K	CERAMIC	220PF	K
C176			CE04KW2A4R7M	ELECTRO	4.7UF	100WV
C177,178			CK45FB1H221K	CERAMIC	220PF	K
C179,180			CQ93FM1H182J	MYLAR	1800PF	J
C181,182			CQ93FM1H222J	MYLAR	2200PF	J
C183,184			CQ93FM1H272J	MYLAR	2700PF	J
C185,186			CQ93FM1H332J	MYLAR	3300PF	J
C187-189			CK45FB1H331K	CERAMIC	330PF	K
C191			CK45FB1H103K	CERAMIC	0.010UF	K
C192			CE04KW1C101M	ELECTRO	100UF	16WV
C193			CK45FB1H103K	CERAMIC	0.010UF	K
C194			CE04KW1C101M	ELECTRO	100UF	16WV
C195			CE04KW2A4R7M	ELECTRO	4.7UF	100WV
C196			CE04KW1C101M	ELECTRO	100UF	16WV
C197,198			CE04KW1V102M	ELECTRO	1000UF	35WV
C199,200			CK45FB1H103K	CERAMIC	0.010UF	K
C201			CE04KW1H330M	ELECTRO	33UF	50WV
C202			CE04KW1H100M	ELECTRO	10UF	50WV
C203			CE04KW1J471M	ELECTRO	470UF	63WV
C204			CK45FB2H103Z	CERAMIC	0.010UF	Z
C205			CE04KW1J101M	ELECTRO	100UF	63WV
C206			CE04KW1H470M	ELECTRO	47UF	50WV

L : Scandinavia K : USA P : Canada R : Mexico
Y : PX(Far East, Hawaii) T : Europe E : Europe G : Germany
Y : AAFES(Europe) X : Australia M : Other Areas

△ indicates safety critical components.

PARTS LIST

* New Parts
Parts without **Parts No.** are not supplied.
Les articles non mentionnés dans le **Parts No.** ne sont pas fournis.
Teile ohne **Parts No.** werden nicht geliefert.

③

Ref. No	Add-ress	New Parts	Parts No.	Description	Desti-nation	Re-marks
C207			CE04KW1C221M	ELECTRO 220UF 16WV		
C208,209			CE04KW2A010M	ELECTRO 1.0UF 100WV		
C210,211			CK45FB1H221K	CERAMIC 220PF K		
C214,215			CK45FB1H221K	CERAMIC 220PF K		
C217			CE04KW2A010M	ELECTRO 1.0UF 100WV		
C218,219			CE04KW1C101M	ELECTRO 100UF 16WV		
C220			C91-1441-08	CERAMIC 4700PF 250WV		
C301			CE04KW1C221M	ELECTRO 220UF 16WV		
C302			CE04KW1C470M	ELECTRO 47UF 16WV		
C303			CE04KW1C470M	ELECTRO 47UF 16WV		
C304		*	C90-3741-08	BACKUP C 0.047F 5.5WV		
C305			CK45FB1H103K	CERAMIC 0.010UF K		
C306			CE04KW1H101M	ELECTRO 100UF 50WV		
C307			CK45FB1H103K	CERAMIC 0.010UF K		
C308			CE04KW1H010M	ELECTRO 1.0UF 50WV		
C309			CK45FB1H103K	CERAMIC 0.010UF K		
C311			CK45FB1H103K	CERAMIC 0.010UF K		
C312			CE04KW1C470M	ELECTRO 47UF 16WV		
C313			CQ93FM1H122J	MYLAR 1200PF J		
C314			CQ93FM1H102J	MYLAR 1000PF J		
C315-320			CE04KW1H100M	ELECTRO 10UF 50WV		
C321			CE04KW1J470M	ELECTRO 47UF 63WV		
C322,323			CK45FB1H103K	CERAMIC 0.010UF K		
C324,325			CK45FB1H104Z	CERAMIC 0.10UF Z		
C326,327			CK45FB1H103K	CERAMIC 0.010UF K		
C332			CK45FB1H103K	CERAMIC 0.010UF K		
C401,402			C91-0769-05	CERAMIC 0.010UF K		
A0101			E03-0322-08	SOCKET,POWER RECEPTACLE	T	
A0101			E03-0323-08	SOCKET,POWER RECEPTACLE	KPY	
A0101			E03-0324-08	SOCKET,POWER RECEPTACLE	EM	
A0101			E03-0334-08	SOCKET,POWER RECEPTACLE	X	
A0101		*	E03-0358-08	SOCKET,POWER RECEPTACLE	C	
JACK101,2			E63-0186-08	TER,RCA,4PIN		
JACK103			E11-0188-05	JACK,D3.5		
W101			E40-9986-08	CN.WAFER,2P		
W102			E35-1608-08	CN.WAFER,2P	KPTECX	
W102		*	E40-8207-08	CN.WAFER,3P	MY	
W301			E40-8003-08	CN.WIRE 4P		
W302			E40-8001-08	CN.WIRE 11P		
W305			E40-9971-08	CN.WAFER 3P		
W306			E35-1606-08	CN.WAFER,5P		
F102			F05-1612-05	FUSE(250V,T1.6)	EXCTMY	
L103			L39-0085-05	COIL,0.5UH		
T301		*	L07-2516-08	POWER TRANSFORMER	ET	
T301		*	L07-2517-08	POWER TRANSFORMER	MY	
T301		*	L07-2518-08	POWER TRANSFORMER	KP	
T301		*	L07-2519-08	POWER TRANSFORMER	C	
T301		*	L07-2520-08	POWER TRANSFORMER	X	
X301,302			L78-0676-08	RESONATOR,CERAMIC		
AR101-104		*	R90-0491-08	R,NETWORK 820KX8		
AR301-315			R90-0500-05	MULTI-COMP 100KX6 J 1/4W		
AR316			R90-0944-08	R,NETWORK 100KX8		
FR154,155			RS14GB3D391J	FL-PROOF RS 390 J2W		

L : Scandinavia K : USA P : Canada R : Mexico
Y : PX(Far East, Hawaii) T : Europe E : Europe G : Germany
Y : AAFES(Europe) X : Australia M : Other Areas

⚠ indicates safety critical components.

* New Parts
Parts without **Parts No.** are not supplied.
Les articles non mentionnés dans le **Parts No.** ne sont pas fournis.
Teile ohne **Parts No.** werden nicht geliefert.

④

Ref. No	Add-ress	New Parts	Parts No.	Description	Desti-nation	Re-marks
R301			RD14GB2E271J	FL-PROOF RD 270 J 1/4W		
S940			T99-0595-08	SW,ROTARY		
SW101			S68-0080-08	SW,PUSH (POWER)		
SW102			S62-0046-08	SW,SLIDE (VOLTAGE)	YM	
SW401-428			S70-0046-08	SW,TACT		
D101-107			1SS131	DIODE		
D108-117			1N4002A	DIODE		
D118,119			1SS131	DIODE		
D301-313			1SS131	TRANSISTOR		
D315			1SS131	TRANSISTOR		
D317			1SS131	TRANSISTOR		
F103			ICP-N15	IC(PROTECT IC)		
FLT301	1B		FIP21BMW24	DISPLAY		
IC101			NJU7311AL	IC(ANALOG SWITCH)		
IC102,103			M5229P	IC(7CH GRAPHIC EQUALIZER)		
IC104,105			NJU7305L	IC(ELECTRIC VOLUME)		
IC106,107			M5229P	IC(7CH GRAPHIC EQUALIZER)		
IC108			NJM4558DD	IC(OP AMP X2)		
IC109			NJM7815FA	IC		
IC110			NJM7915FA	IC		
IC301			LC867224A-5D35	IC		
IC302			LC867224A-5D36	IC		
IC303			TC4051BP	IC(8CH MPX/ DE-MPX)		
IC304,305			XR1091	IC(DISPLAY FILTER)		
IC306			KIA7039P	IC		
Q101			DTA124TS	TRANSISTOR		
Q102			2SA933S	TRANSISTOR		
Q103		*	KTB1366Y	TRANSISTOR		
Q104			DTC124ES	TRANSISTOR		
Q105,106			KTC2878	TRANSISTOR		
Q301			2SC1740S	TRANSISTOR		
Q302			DTC114ES	TRANSISTOR		
Q303-333			DTA124ES	TRANSISTOR		
Q334			KTA1271Y	TRANSISTOR		
Q335-388			DTA124ES	TRANSISTOR		
Q389			DTC114ES	TRANSISTOR		
Q390,391			DTA124ES	TRANSISTOR		
Q392			KTC3227Y	TRANSISTOR		
Q393			KTD2058Y	TRANSISTOR		
Q394			2SA933S	TRANSISTOR		
Q395			DTC114ES	TRANSISTOR		
ZD101			MTZ6.8B	ZENER DIODE		
ZD102			MTZ5.1B	ZENER DIODE		
ZD103			MTZ6.2B	ZENER DIODE		
ZD104			MTZ6.8B	ZENER DIODE		
ZD301,302			MTZ6.2B	TRANSISTOR		
ZD303			MTZ2.7B	TRANSISTOR		
ZD304,305			MTZ4.7B	TRANSISTOR		
ZD306			MTZ5.6B	TRANSISTOR		

L : Scandinavia K : USA P : Canada R : Mexico
Y : PX(Far East, Hawaii) T : Europe E : Europe G : Germany
Y : AAFES(Europe) X : Australia M : Other Areas

⚠ indicates safety critical components.

G-EQ300

SPECIFICATIONS

[Audio block]

Total harmonic distortion (at 1 kHz, Flat)	0.005%
Frequency response	10 Hz ~ 70 kHz, ± 3 dB
Signal to noise ratio (IHF '66)	108 dB
Graphic equalizer characteristics	
Adjustment center frequencies	40 Hz, 63 Hz, 98 Hz, 160 Hz, 250 Hz, 400 Hz, 625 Hz, 1 kHz, 1.5 kHz, 2.5 kHz, 3.9 kHz, 6.3 kHz, 10 kHz, 16 kHz
Equalizer characteristic variable range	± 12 dB
Input impedance	
Line	47 k Ω
Maximum output voltage (at 1% T.H.D.)	7 V
Output Impedance	
Line	2.2 k Ω

[General]

AC outlets	
For the U.S.A. and Canada	
UNSWITCHED	1 (200W, 1.6A max.)
For other countries	
UNSWITCHED	1 (200W max.)
Power consumption	18 W
Dimensions	W : 400 mm (15-3/4") H : 141 mm (5-9/16") D : 375 mm (15-3/16")
Weight (net)	4.6 kg (10.2 lb)



1. KENWOOD follows a policy of continuous advancements in development. For this reason specifications may be changed without notice.
2. Sufficient performance may not be possible at very low temperatures (0°C or less).

Note:

Component and circuit are subject to modification to insure best operation under differing local conditions. This manual is based on Europe (E) standard, and provides information on regional circuit modification through use of alternate schematic diagrams, and information on regional component variations through use of parts list.

KENWOOD CORPORATION

14-6, Dogenzaka 1-chome, Shibuya-ku, Tokyo, 150 Japan

KENWOOD SERVICE CORPORATION

P.O. BOX 22745, 2201 East Dominguez St., Long Beach, CA 90801-5745, U.S.A.

KENWOOD ELECTRONICS CANADA INC.

6070 Kestrel Road, Mississauga, Ontario, Canada L5T 1S8

KENWOOD ELECTRONICS LATIN AMERICA S.A.

P.O. BOX 55-2791, Piso 6 plaza Chase, Cl. 47 y Aquilino de la Guardia Panama, Republic de Panama

KENWOOD ELECTRONICS U.K. LIMITED

KENWOOD House, Dwight Road, Watford, Herts., WD1 8EB., United Kingdom

KENWOOD ELECTRONICS BENELUX N.V.

Meachelsesteenweg 418, B-1930 Zaventem, Belgium

KENWOOD ELECTRONICS DEUTSCHLAND GMBH

Rembrücker Str. 15, 63150 Heusenstamm, Germany

KENWOOD ELECTRONICS FRANCE S.A.

13 Boulevard Ney, 75018 Paris, France

KENWOOD ELECTRONICS ITALIA S.p.A.

Via G. Sirtori, 7/9 20129, Milano, Italy

KENWOOD IBÉRICA S.A.

Bolivia, 239-08020 Barcelona, Spain

KENWOOD ELECTRONICS AUSTRALIA PTY. LTD.

(A.C.N. 001499 074)

P.O. Box 504, 8 Figtree Drive, Australia Centre, Homebush, N.S.W. 2140, Australia

KENWOOD & LEE ELECTRONICS, LTD.

Unit 3712-3724, Level 37, Tower 1, Metroplaza, 223 Hing Fong Road, Kwai Fong N.T., Hong Kong

KENWOOD ELECTRONICS GULF FZE

P.O. Box 61318, Jebel Ali, Dubai, U.A.E.

KENWOOD ELECTRONICS SINGAPORE PTE LTD.

No. 1 Genting Lane #02-02, KENWOOD Building, Singapore, 349544

KENWOOD ELECTRONICS (MALAYSIA) SDN BHD.

#4.01 Level 4, Wisma Academy Lot 4A, Jalan 19/1 46300 Petaling Jaya Selangor Darul Ehsan Malaysia